

Creativ Design



Aktuelle Formen aus
Rundmaterial 12 mm



Trifbenbacher Schmiedeeisen



Füllelemente

Maßstab 1:10

Ornamental panels / Panneaux décoratifs

Scale / Echelle 1:10

Triebener Eisenwerke Schmiedeeisen

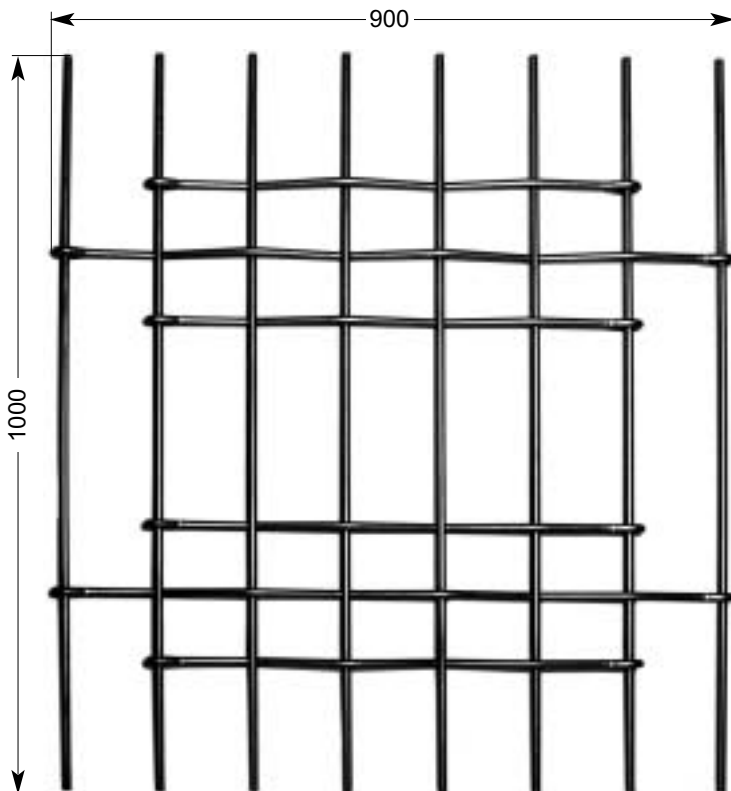

26 454*
11,50 kg
Ø 12 mm

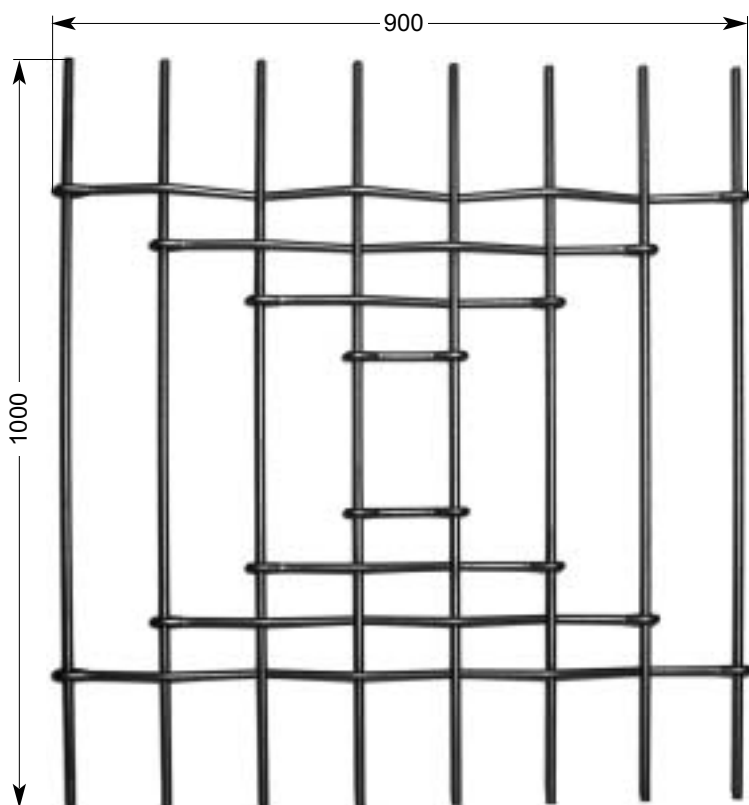

26 455*
11,50 kg
Ø 12 mm



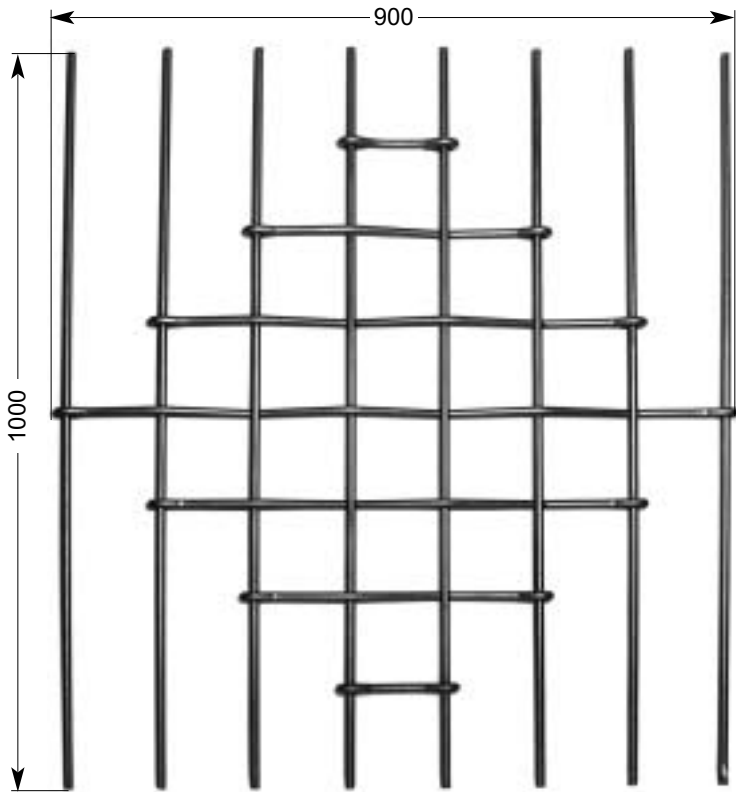

26 453*
11,00 kg
Ø 12 mm

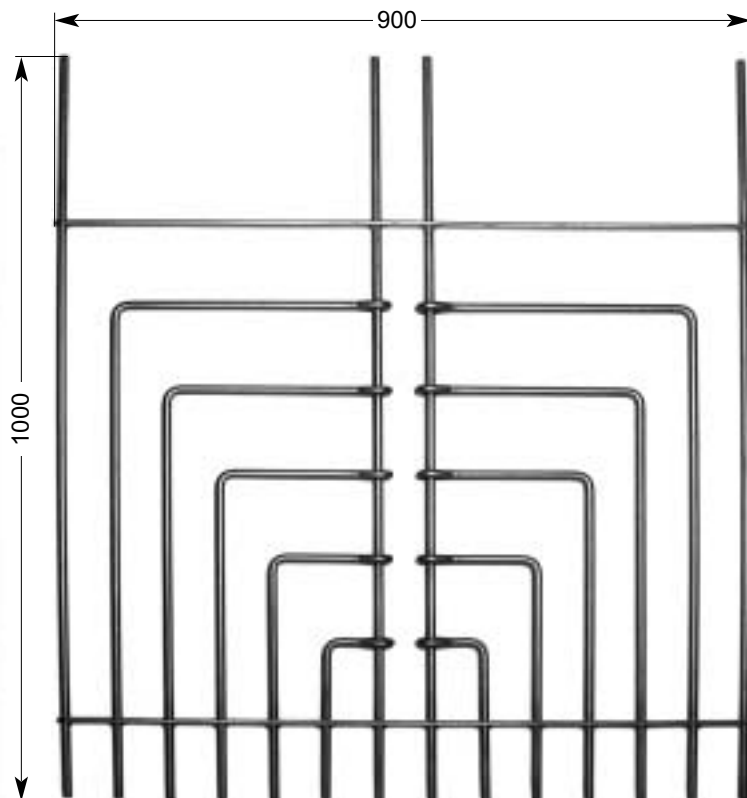

26 456*
11,05 kg
Ø 12 mm



Füllelemente

Maßstab 1:10

Ornamental panels / Panneaux décoratifs

Scale / Echelle 1:10

Triebener Eisenwerke Schmiedeeisen

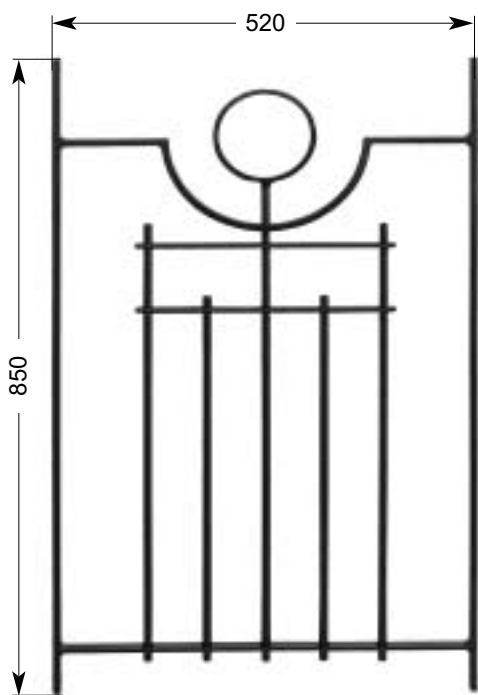
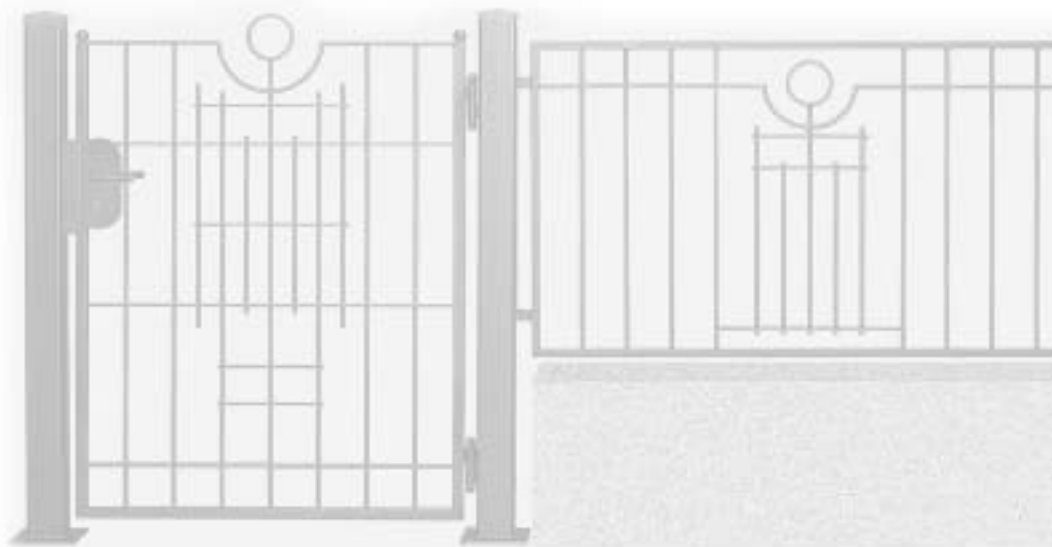

22 710
7,50 kg
Ø 12 mm
□ 20 x 10 mm

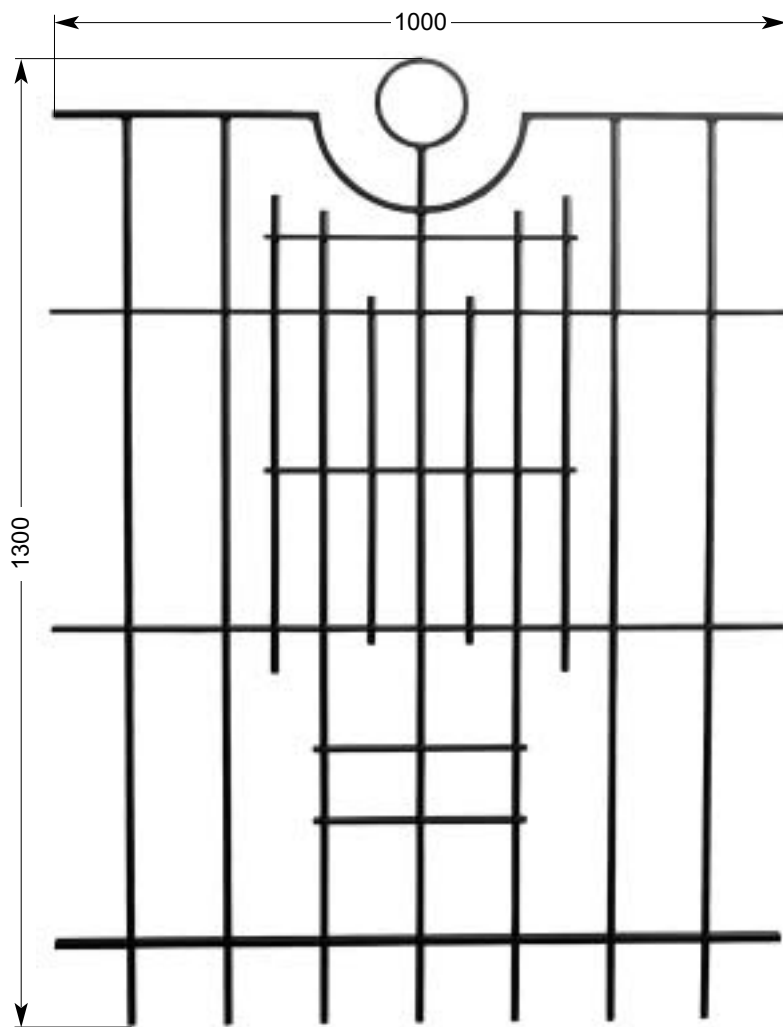

22 720
16,00 kg
Ø 12 mm
□ 20 x 6 mm / 20 x 10 mm

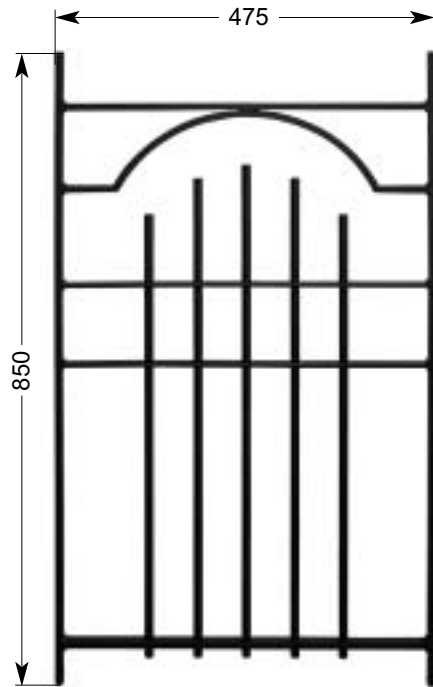
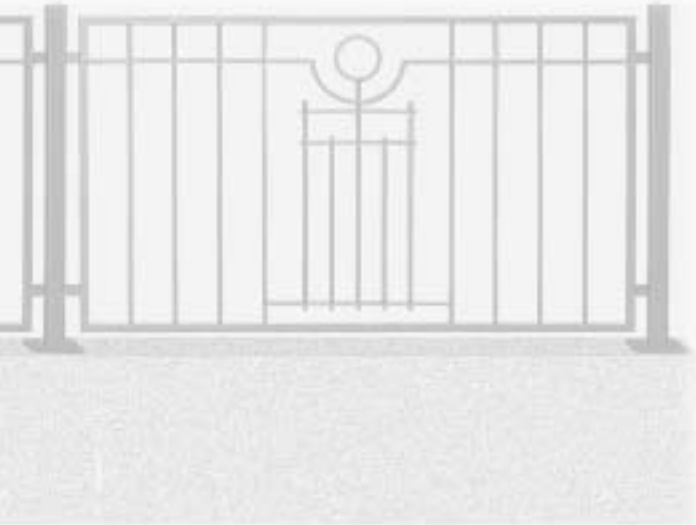

22 712

8,50 kg

∅ 12 mm

□ 20 x 10 mm

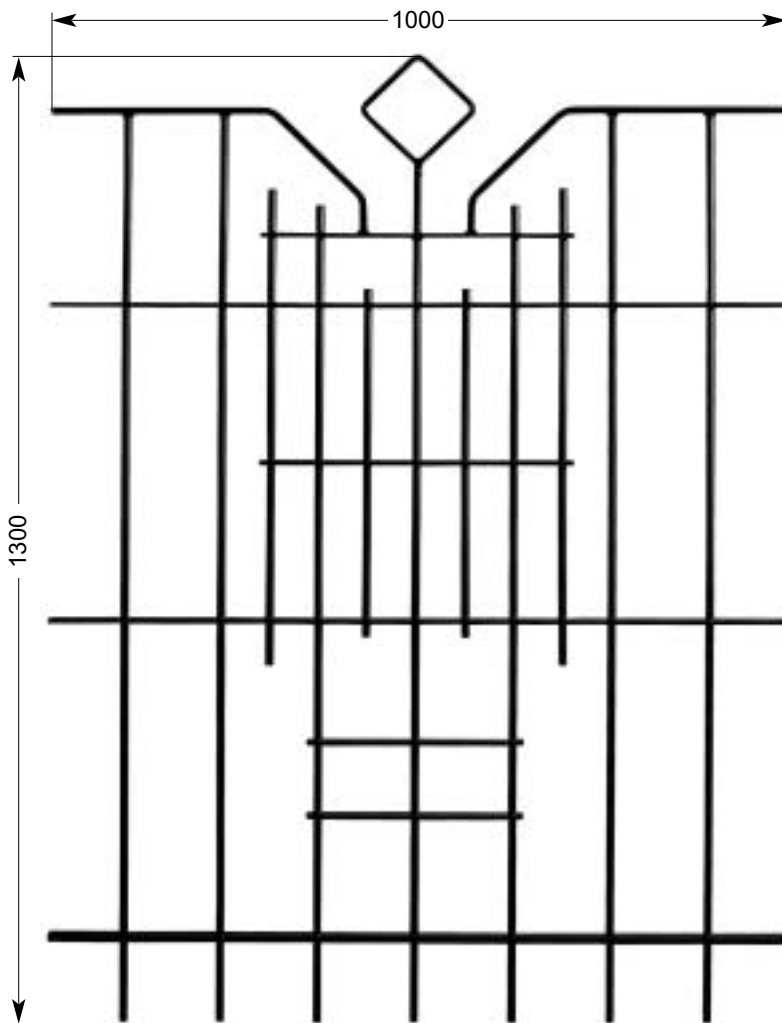

22 721

16,00 kg

∅ 12 mm

□ 20 x 6 mm / 20 x 10 mm

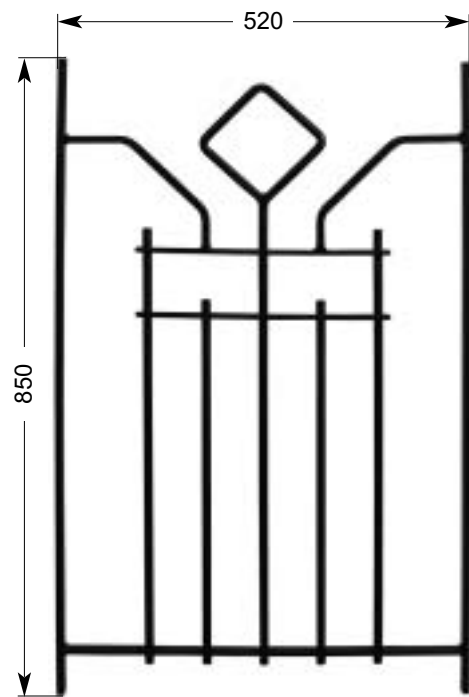

22 711

7,50 kg

∅ 12 mm

□ 20 x 10 mm



Füllelemente

Maßstab 1:10

Ornamental panels / Panneaux décoratifs

Scale / Echelle 1:10

Triebbacher Schmiedeeisen

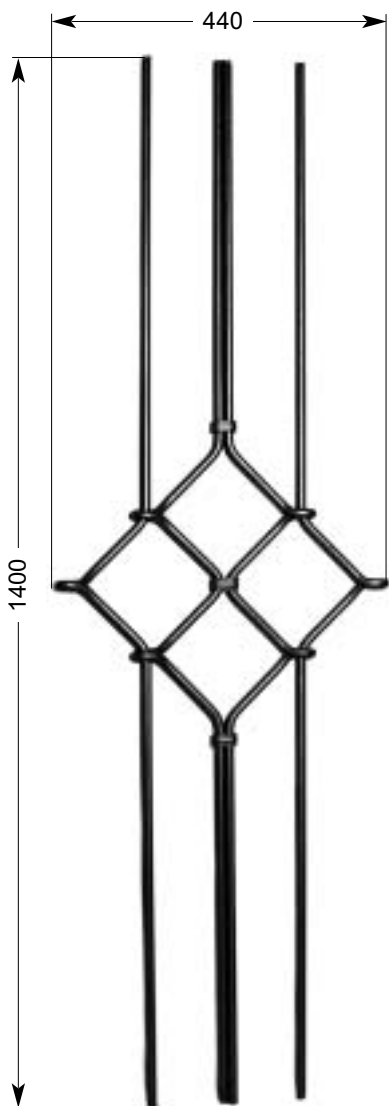

26 447*
5,70 kg
Ø 12 mm

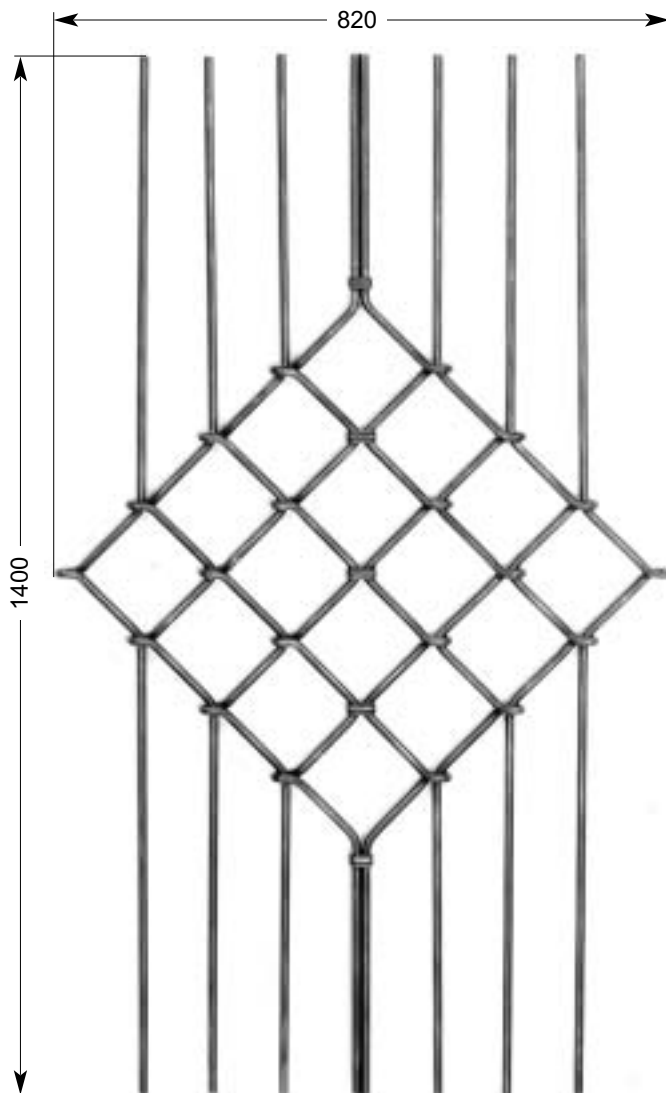

26 445*
12,60 kg
Ø 12 mm



Ornamental panels / Panneaux décoratifs

Scale / Echelle 1:10

Füllelemente

Maßstab 1:10

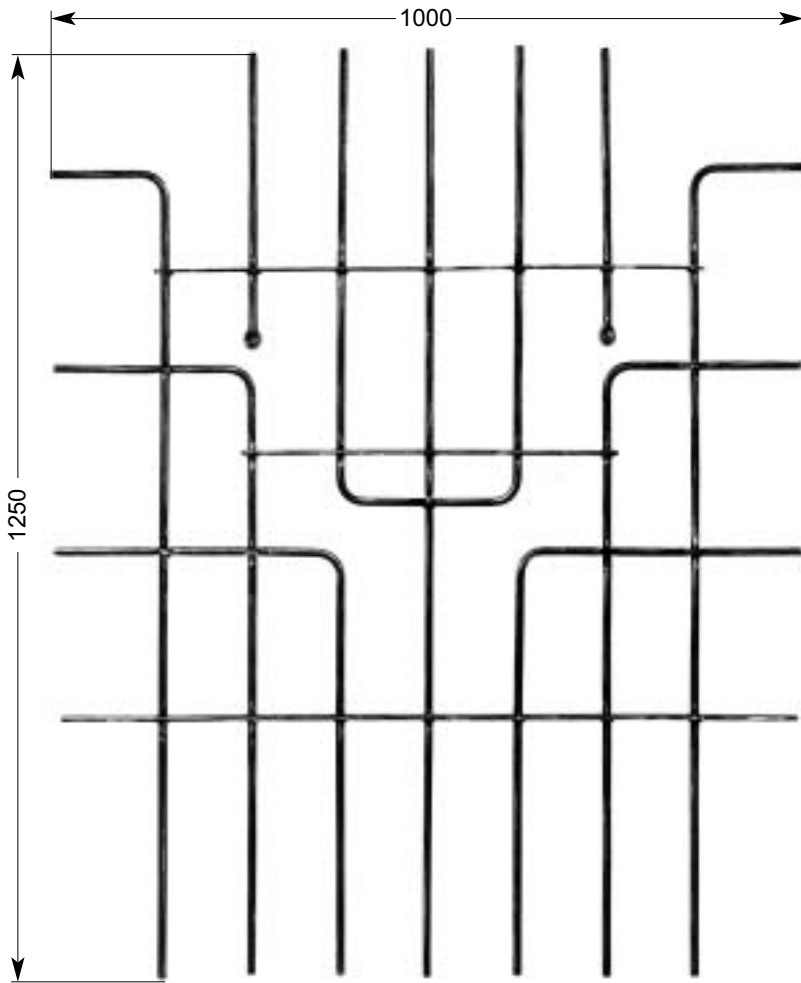

26 498
11,80 kg
Ø 12 mm
□ 30 x 6 mm

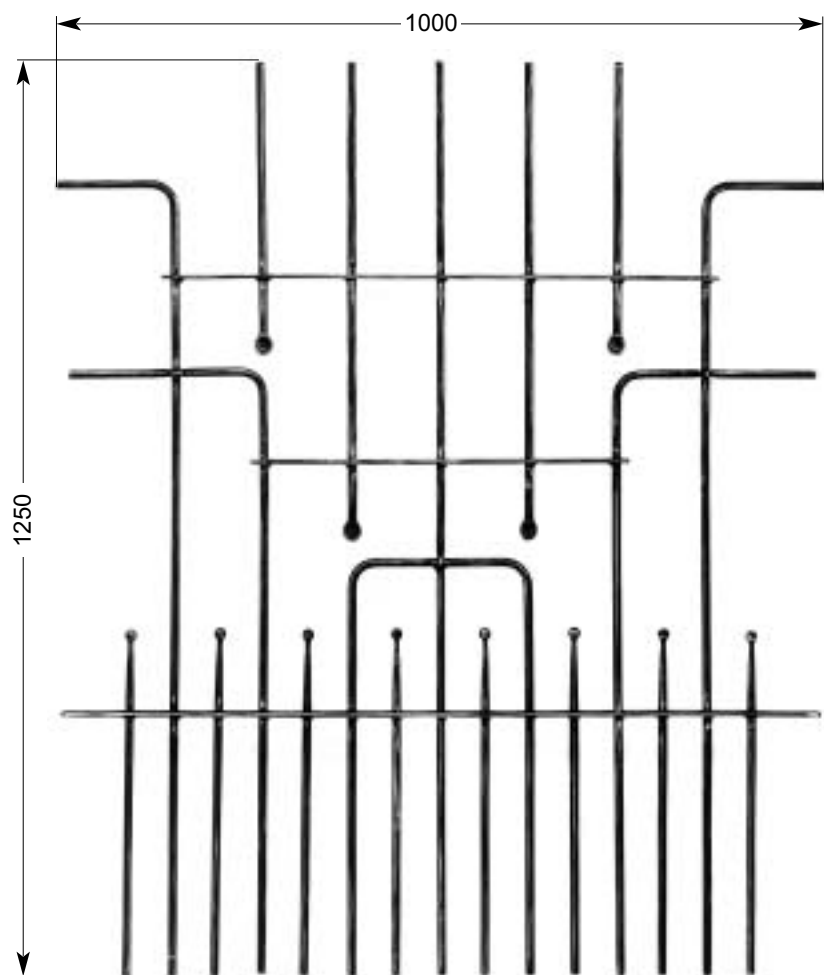

26 497
15,00 kg
Ø 12 mm
□ 30 x 6 mm

* Geschmacksmuster geschützt / Protection of designs / Modèle déposé

Triebener Eisenwerke Schmiedeeisen



Füllelemente

Maßstab 1:10

Ornamental panels / Panneaux décoratifs

Scale / Echelle 1:10

Triebbacher Schmiedeeisen

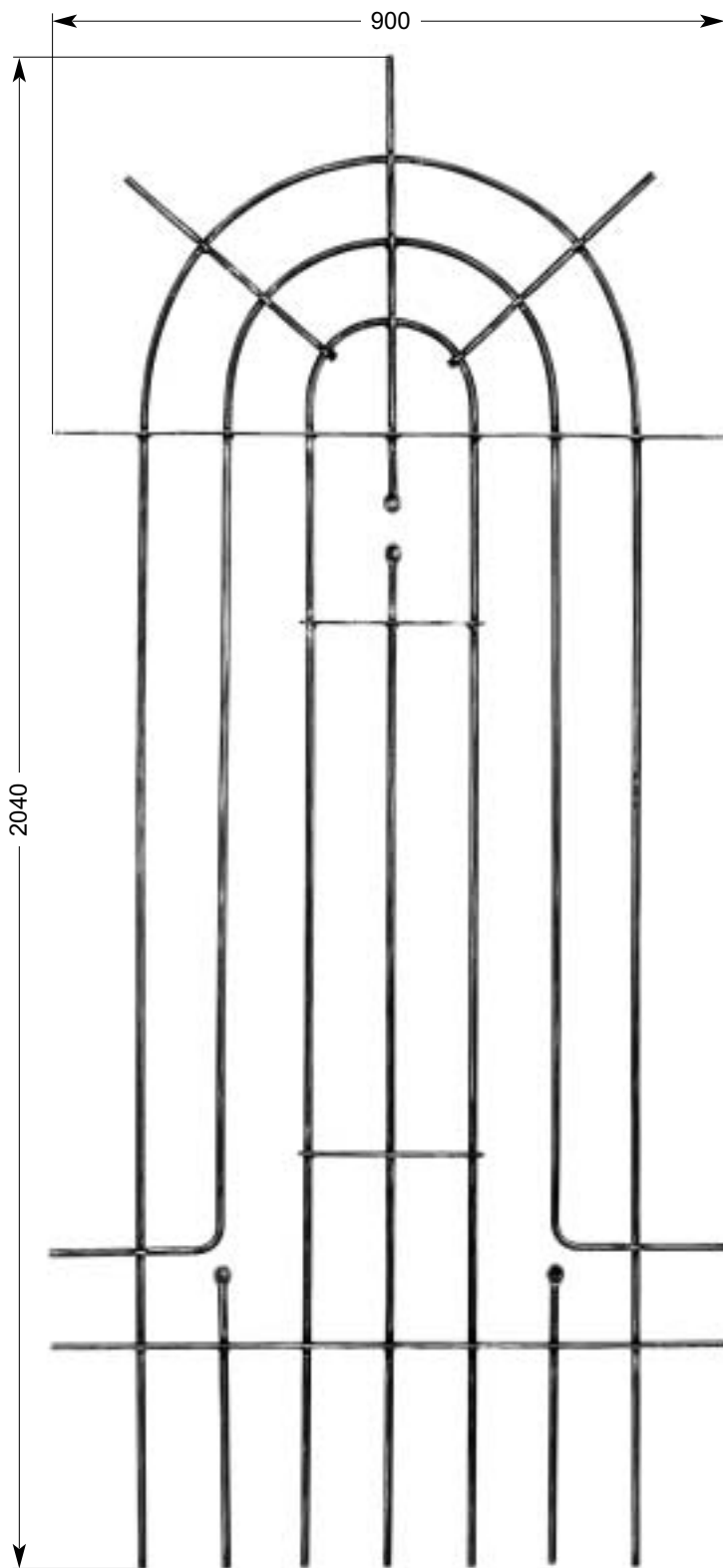

26 495

17,00 kg

Ø 12 mm

□ 30 x 6 mm



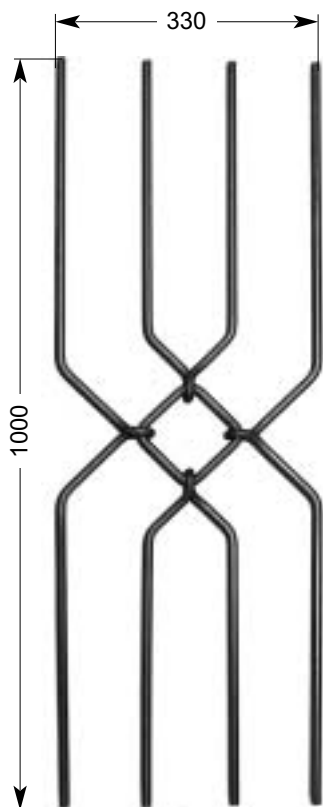
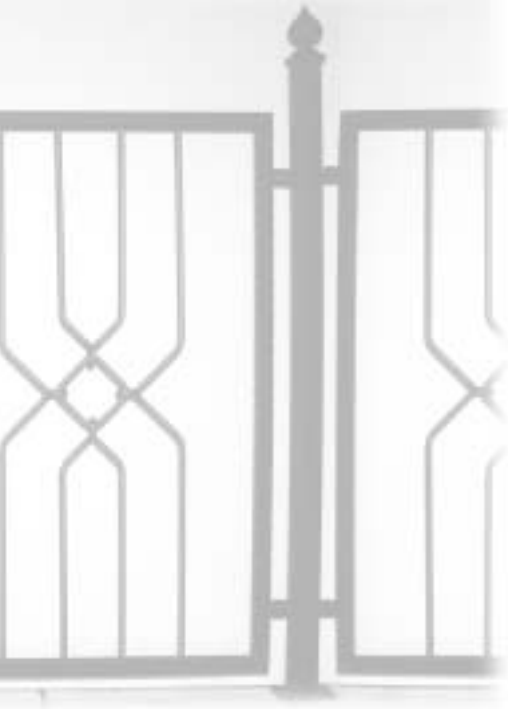

26 446
4,00 kg
Ø 12 mm

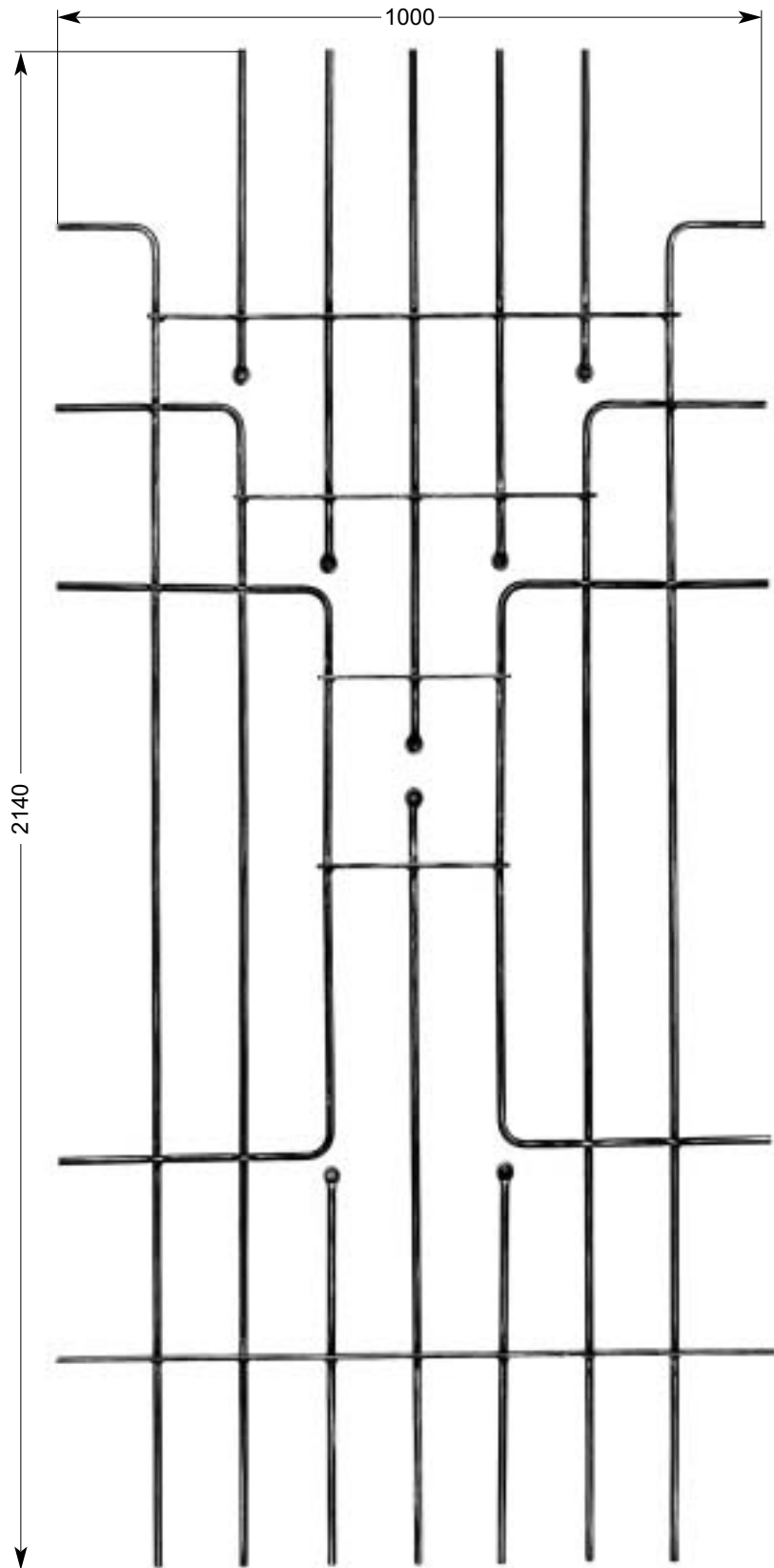

26 496
18,70 kg
Ø 12 mm
□ 30 x 6 mm

Triebener Eisenwerke Schmiedeeisen

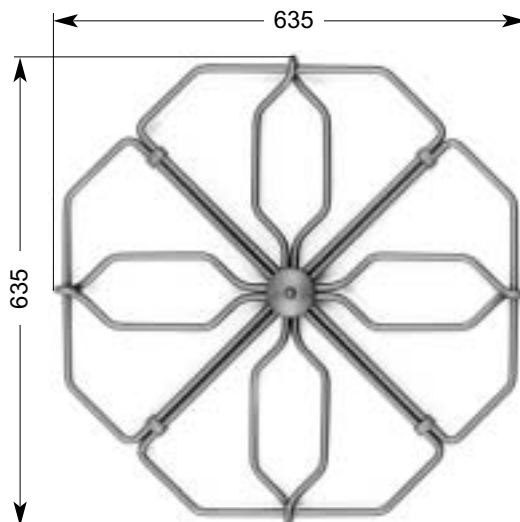

26 443
6,61 kg
Ø 12 mm

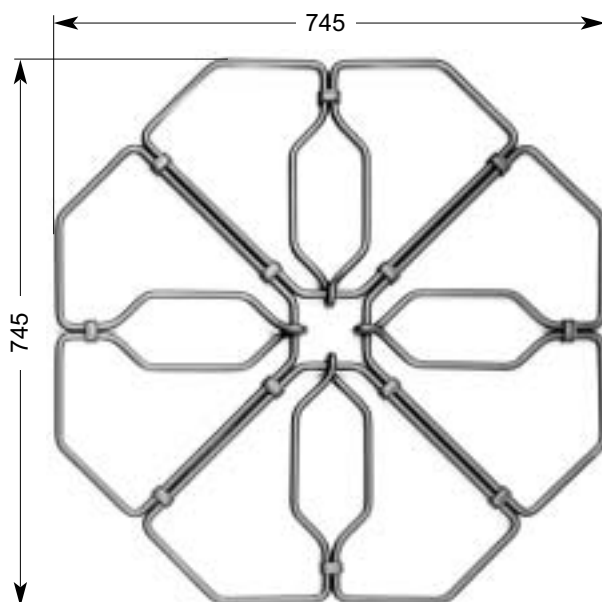

26 444
7,37 kg
Ø 12 mm



24 704

Zierplatte

Ornamental plate

Plaque décorative

0,10 kg

Ø 80 mm

≡ 3 mm



26 432

0,28 kg

Ø 12 mm

Ø 110 mm



26 438

0,26 kg

Ø 12 mm

110 x 110 mm



26 439

0,37 kg

Ø 12 mm

110 x 180 mm



26 440

0,49 kg

Ø 12 mm

110 x 230 mm



26 441

0,20 kg

Ø 12 mm

110 x 90 mm



Gitterstäbe

Maßstab 1:5

Grille bars / Barreaux de grille

Scale / Echelle 1:5

Triebbacher Schmiedeeisen

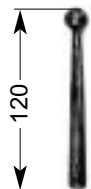

120

26 460

0,10 kg

Ø 12 mm

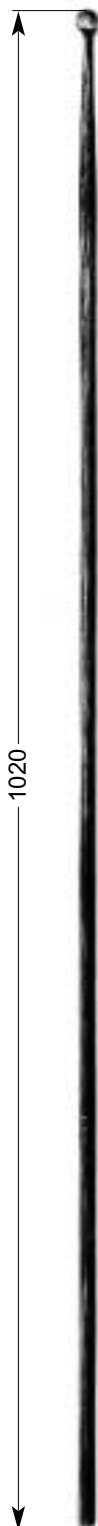

1020

26 462

0,92 kg

Ø 12 mm

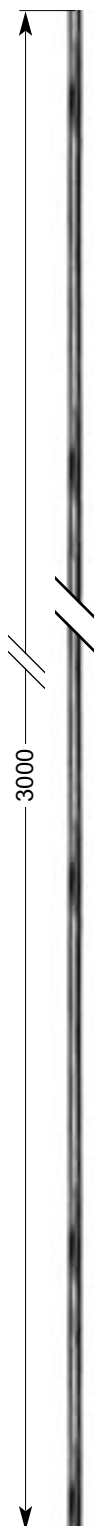

3000

12 112

0,89 kg / m

Ø 12 mm

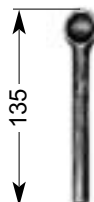

135

26 470

0,10 kg

Ø 12 mm

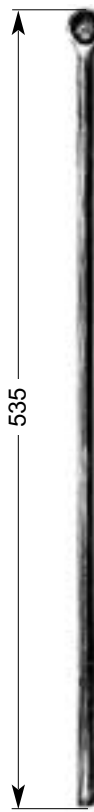

535

26 471

0,45 kg

Ø 12 mm

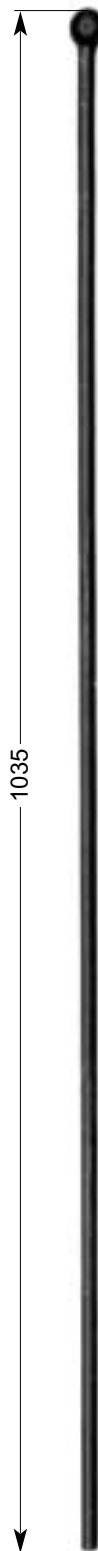

1035

26 472

0,95 kg

Ø 12 mm



1000

31 107

0,89 kg

Ø 12 mm

26 461

0,45 kg

Ø 12 mm



16 502
0,88 kg / m
L. 2 m
Ø 12 mm
⊙ 12,5 mm



16 501
1,57 kg / m
L. 2 m
Ø 16 mm
⊙ 12,5 mm



16 557
1,60 kg / m
L. 2 m
□ 25 x 8 mm
⊙ 13 mm



16 751
1,03 kg / m
L. 1,95 m
□ 25 x 5 mm





Bundmaterial

Maßstab 1:2

Flange material / Fers à grilles

Scale / Echelle 1:2

Bunde / Flanges / Fers

100 St. / pcs. / pcs.

11704 Material / Material / Fers

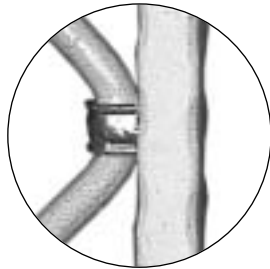

21 371
1,69 kg
> | 12 mm



21 372
3,03 kg
|| 12 - 12 mm

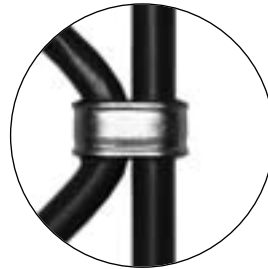

21 373
3,14 kg
> | 12 - 12 mm



21 374
4,03 kg
|| 12 - 12 - 12 mm

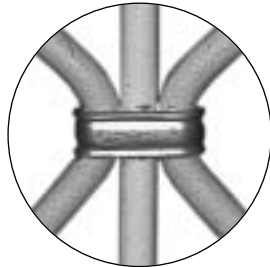

21 375
4,21 kg
> < 12 - 12 - 12 mm

| = gerade Verbindung / for parallel connection / pour produit droit
) = leicht gebogene Verbindung / for volutes elements / pour assemblage volutes
> = stark gebogene Verbindung / for circles / pour assemblage cercle

Maßstab 1:1 / Scale / Echelle



Bundmaterial
Flange material
Fers à grilles

11 704
0,34 kg / m
L. 3 m
16 x 4 mm



Bundmaterial
Flange material
Fers à grilles

11 740
0,50 kg / m
L. 3 m
16 x 5 mm

Triebwägenbau
Schmiedeeisen



Handlaufträger / Handrail brackets / Supports de main courante

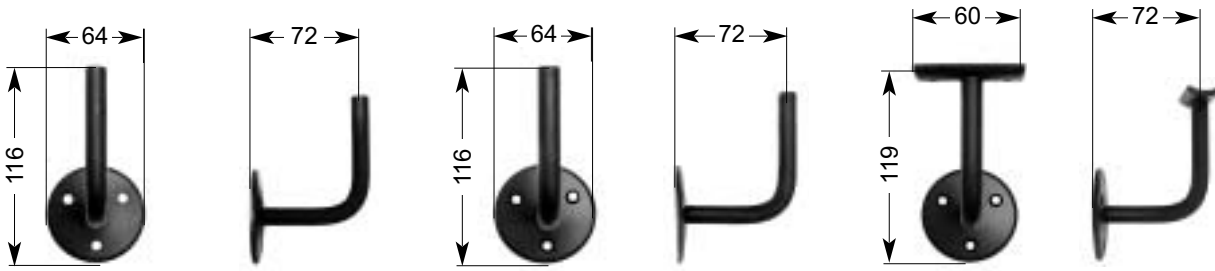

17 619
0,21 kg
Ø 12 mm
⊙ 3 x 6,5 mm

17 620
0,21 kg
Ø 12 mm
⊙ 3 x 6,5 mm

17 623
0,25 kg
Ø 12 mm
⊙ 3 x 6,5 mm

Anschraubplatten / Screwed panels / Plaques



24 311
0,09 kg
Ø 64 mm
⊙ 1 x 12 mm / 3 x 6,5 mm
≡ 4 mm

24 320
0,34 kg
Ø 99 mm
⊙ 4 x 11 mm
≡ 6 mm

24 321
0,27 kg
Ø 99 mm
⊙ 1 x 43 mm / 4 x 11 mm
≡ 6 mm

Abdeckrosetten / Cover rosettes / Rosaces de recouvrement



24 541
0,07 kg
H. 12 mm
Ø 69 mm
⊙ 12,5 mm

24 540
0,16 kg
H. 24 mm
Ø 105 mm
⊙ 43 mm

Anschraubplatte für Rundrohr 42,4 mm
Screwed panel for tube 42,4 mm
Platine pour tube rond 42,4 mm



26 562
0,04 kg
60 x 25 mm
⊙ 1 x 6,5 mm / 2 x 5,5 mm
≡ 4 mm



Handlaufzubehör

Maßstab 1:2

Handrail accessoires / Accessoires de main courante

Scale / Echelle 1:2

Triebwägen Schmirdeisen

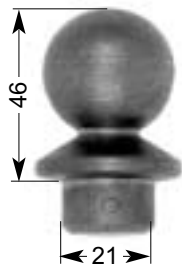

Rohrknöpfe
Pipe knops
Bouton de tube

26 410
0,23 kg
Ø 29 mm

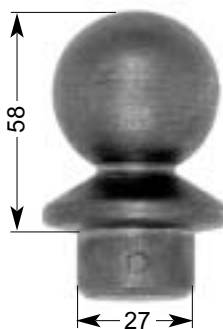

26 408
0,55 kg
Ø 39 mm

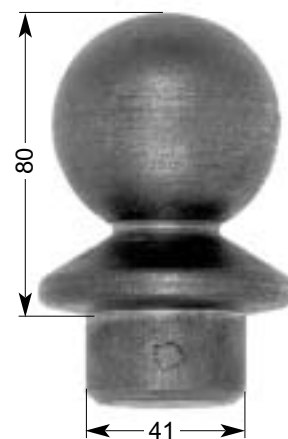

26 412
1,40 kg
Ø 58 mm

Die komplette Auswahl an Handläufen ist in unserer Broschüre Langmaterial
The complete collection of handrails you will find in our brochure long material
Toute les main courante dans le catalogue produit long

Maßstab 1:1 / Scale / Echelle

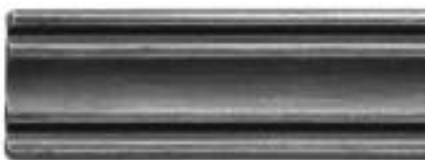

Handlauf
Handrail
Main-courante

11 930
2,26 kg / m
L. 3 m
41 x 8 mm

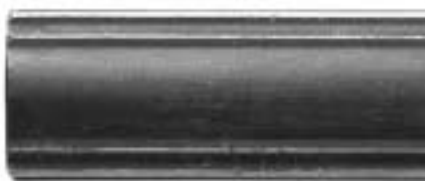

Handlauf
Handrail
Main-courante

11 950
3,40 kg / m
L. 3 m
45 x 13 mm



Handlauf
Handrail
Main-courante

11 960
2,50 kg / m
L. 3 m
40 x 10 mm

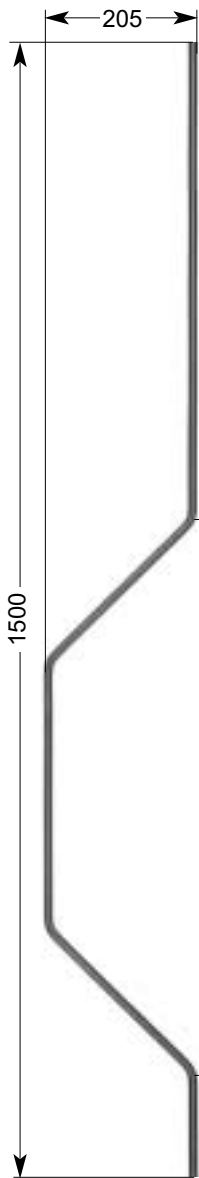

32 101
 1,45 kg
 Ø 12 mm

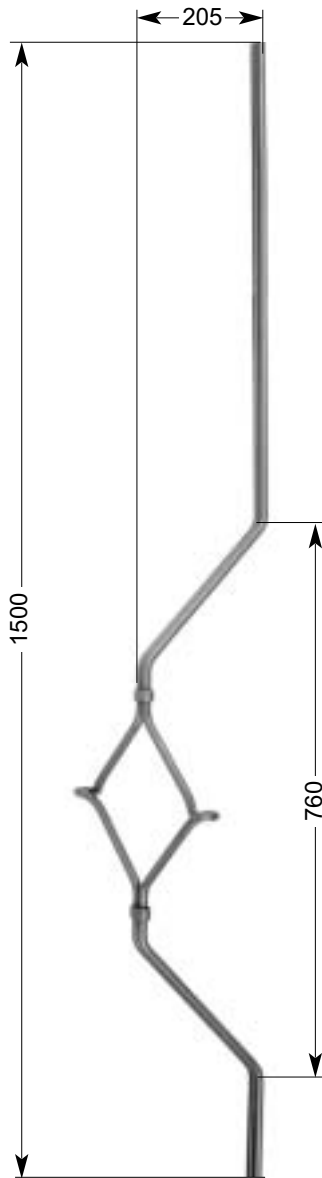

32 102
 3,25 kg
 Ø 12 mm

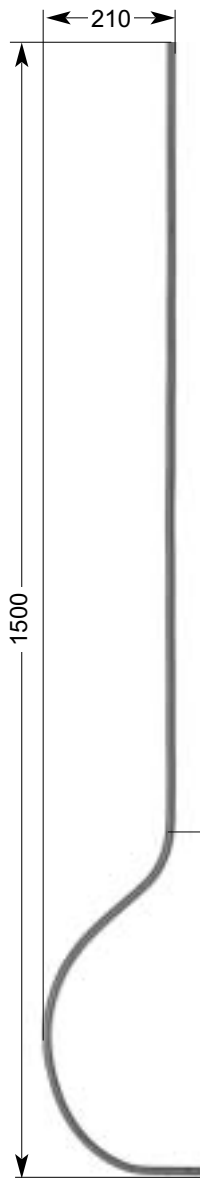

32 108
 1,50 kg
 Ø 12 mm

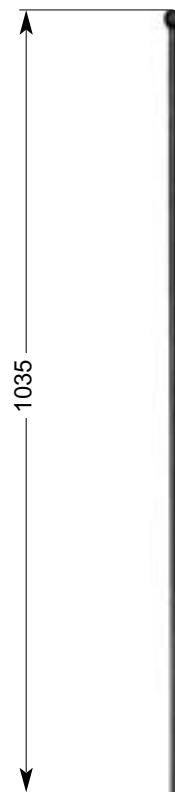
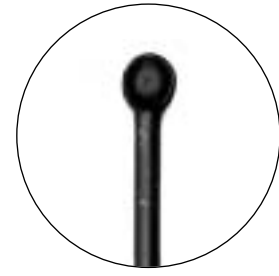

26 472
 Gitterstab
 Grille bar
 Barreaux de grill
 0,95 kg
 Ø 12 mm

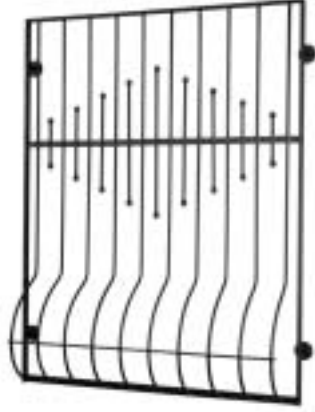
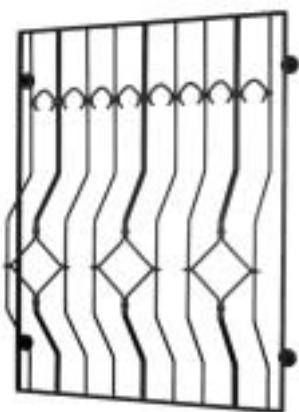



Zierstäbe

Maßstab 1:10

Ornamental balusters / Barreaux décoratifs

Scale / Echelle 1:10

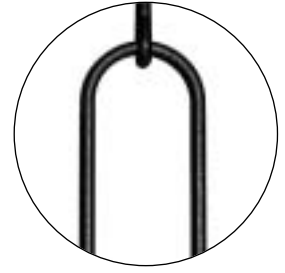
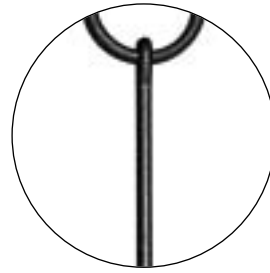
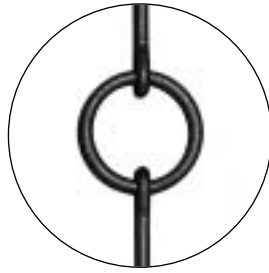

17 742

Anfangsverzierung

Endpost ornament

Ornement de départ

2,40 kg

Ø 75 mm

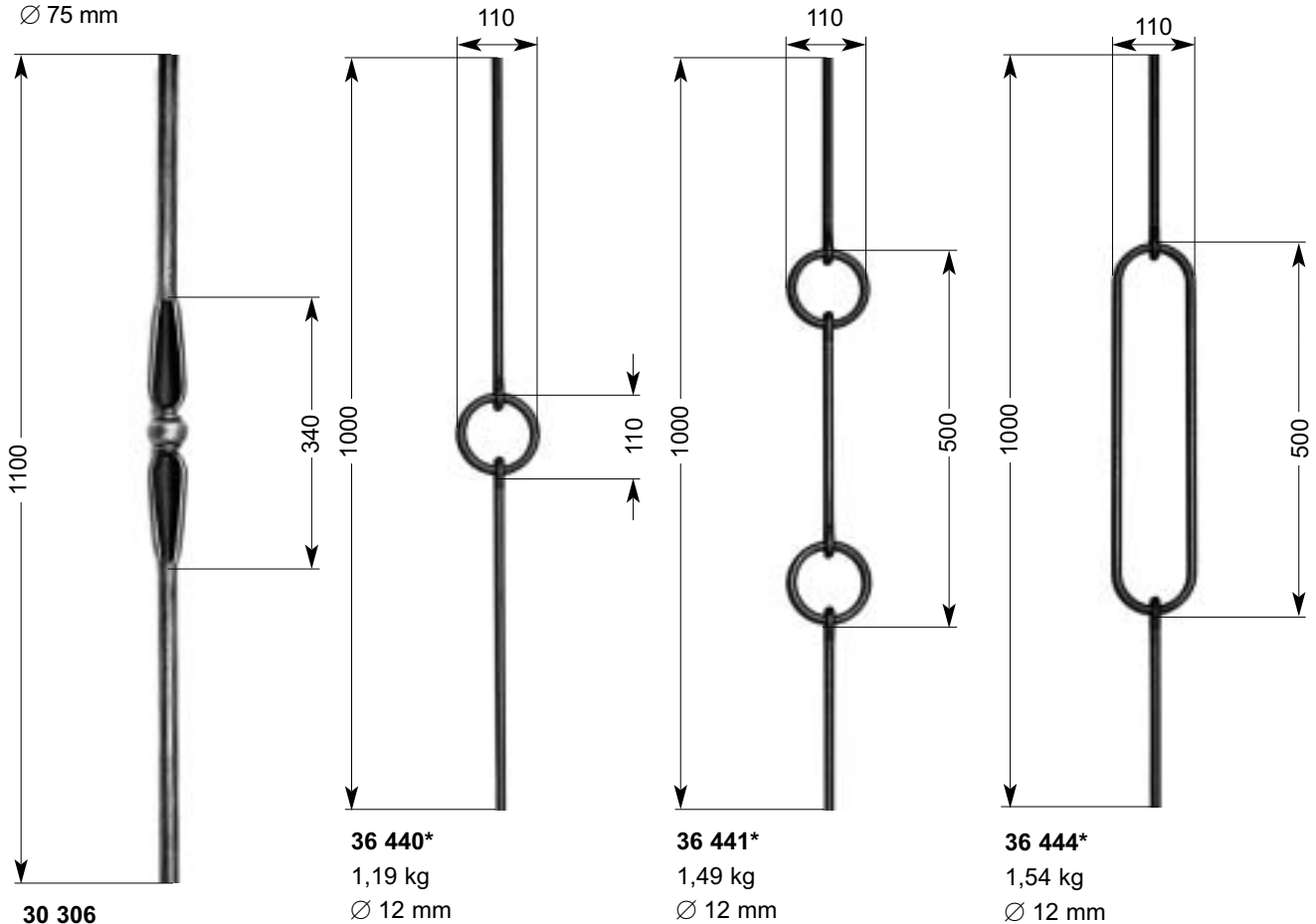

30 306

Anfangsstab

Endpost

Balustre de départ

4,72 kg

Ø 25 mm

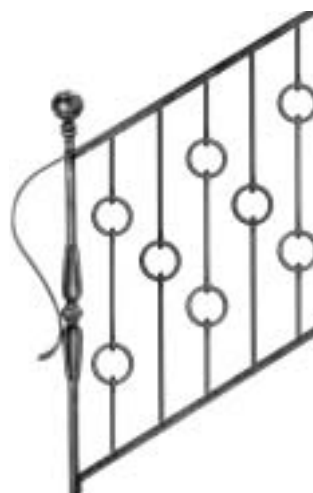
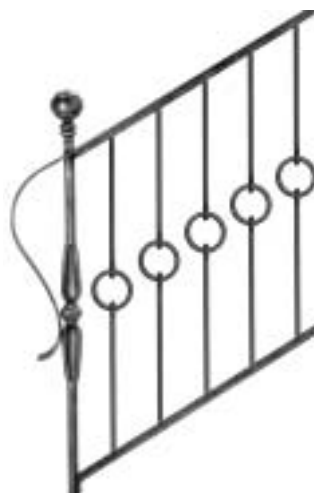

Triebbacher Schmiedeeisen

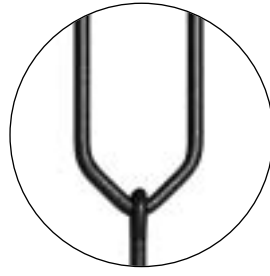
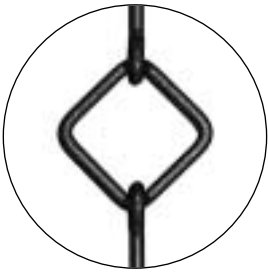

17 741

Anfangsverzierung

Endpost ornament

Ornement de départ

1,70 kg

Ø 65 mm

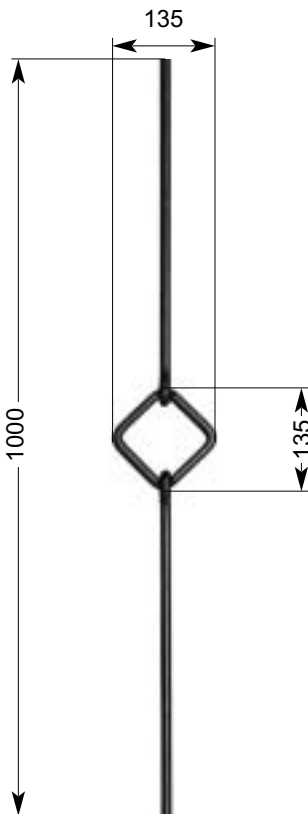

36 442*
1,24 kg
Ø 12 mm

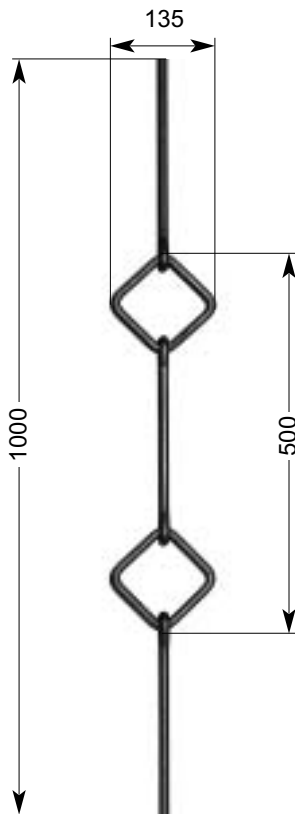

36 443*
1,54 kg
Ø 12 mm

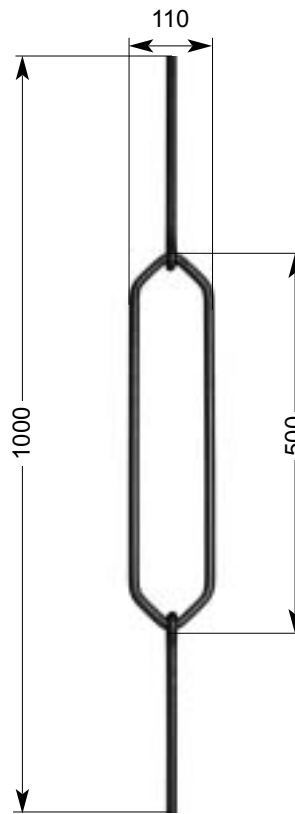

36 445*
1,54 kg
Ø 12 mm

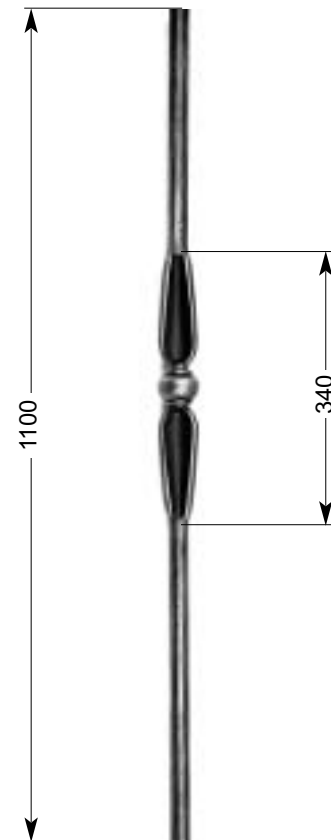

30 307

**Anfangsstab
mit Messingkugel**

Endpost with brass ball

Balustre de départ

boule en laiton

4,72 kg

Ø 25 mm

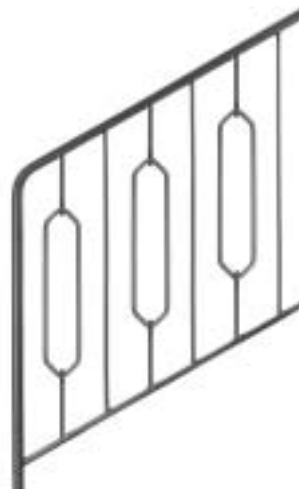
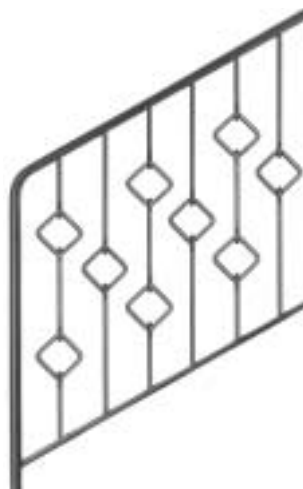
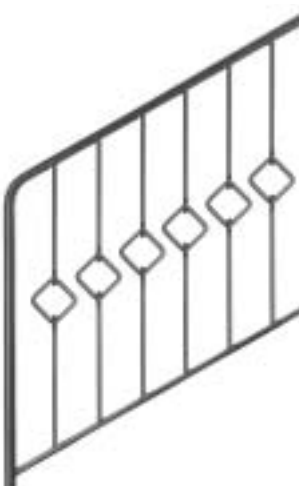



Zierstäbe

Maßstab 1:10

Ornamental balusters / Barreaux décoratifs

Scale / Echelle 1:10

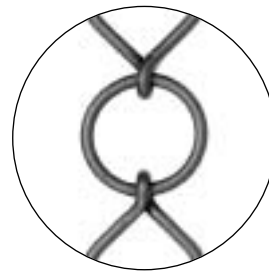
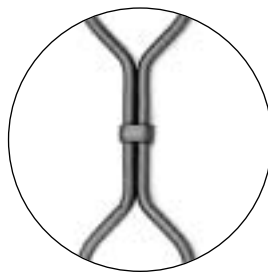
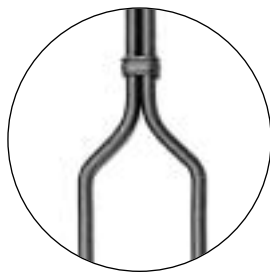

26 412

Rohrkopf

Pipe knob

Bouton de tube

1,46 kg

Ø 58 mm

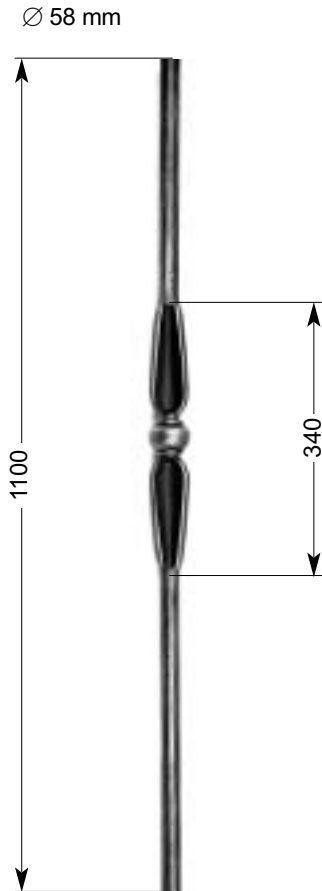

30 306

Anfangsstab

Endpost

Balustre de départ

4,72 kg

Ø 25 mm

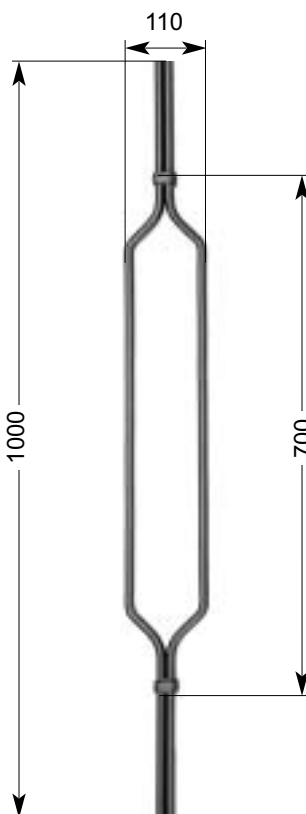

36 401

1,91 kg

Ø 12 mm

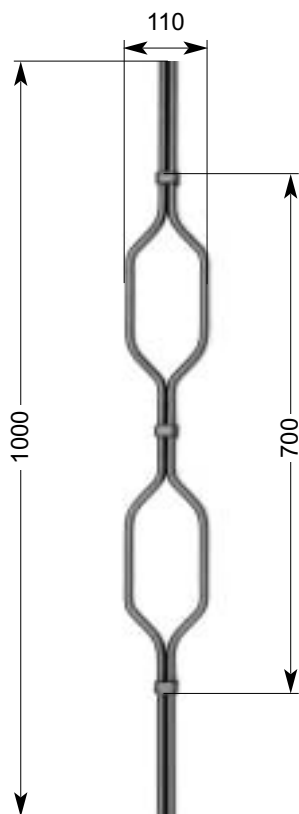

36 402

2,00 kg

Ø 12 mm

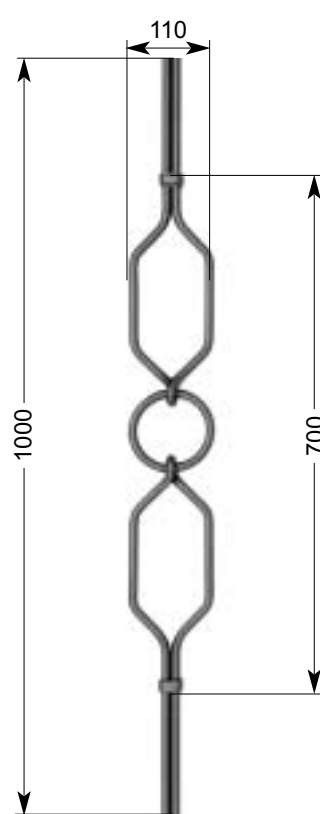

36 403

2,14 kg

Ø 12 mm

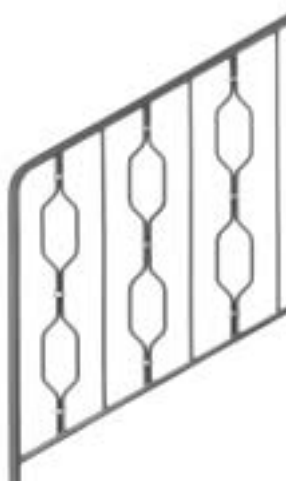
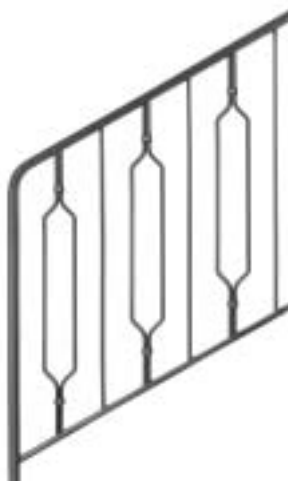

Triebbacher Schmiedeeisen

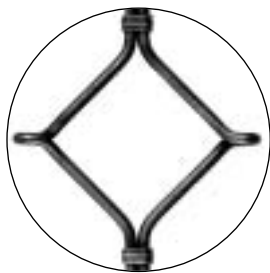
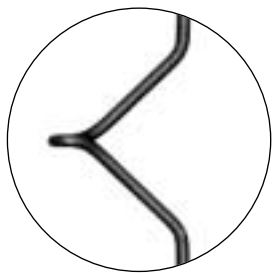

17 741

Anfangsverzierung

Endpost ornament

Ornement de départ

1,70 kg

Ø 65 mm

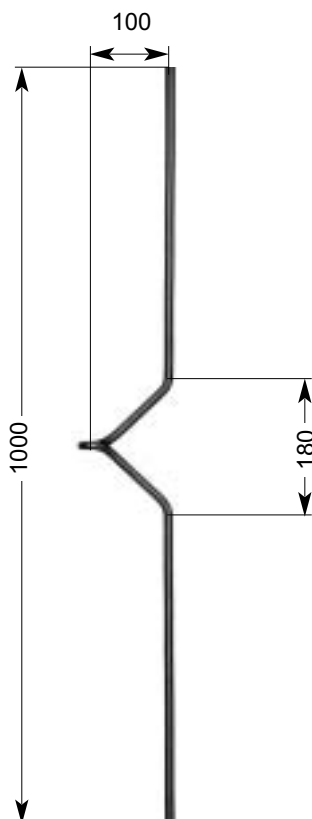

36 404*

1,01 kg

Ø 12 mm

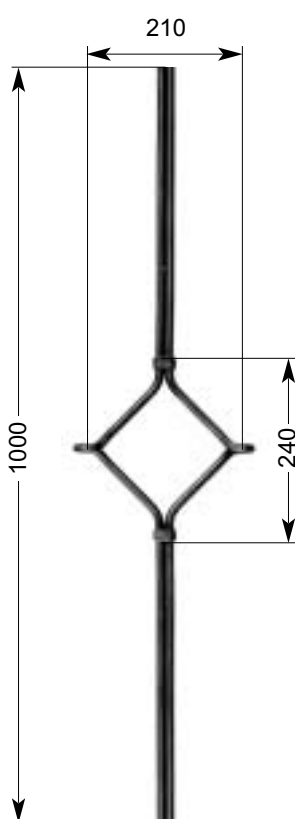

36 405*

2,08 kg

Ø 12 mm

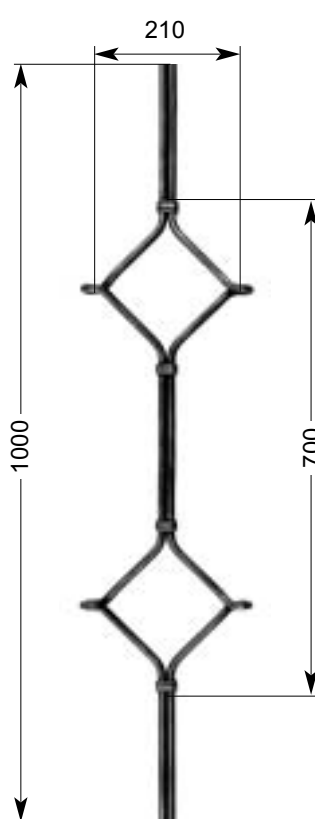

36 425*

2,41 kg

Ø 12 mm

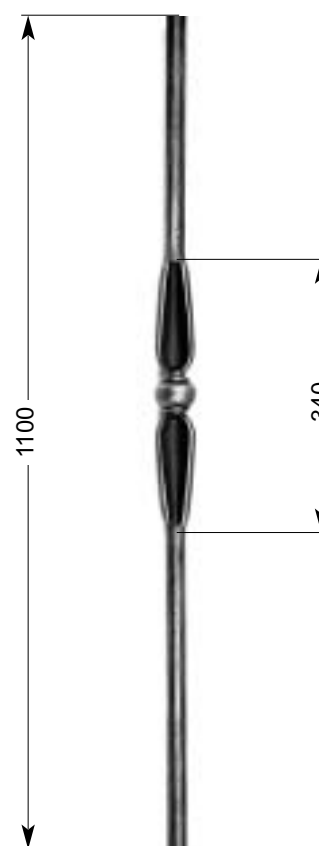

30 307

**Anfangsstab
mit Messingkugel**

Endpost with brass ball

Balustre de départ

boule en laiton

4,72 kg

Ø 25 mm





Zierstäbe

Maßstab 1:10

Ornamental balusters / Barreaux décoratifs

Scale / Echelle 1:10

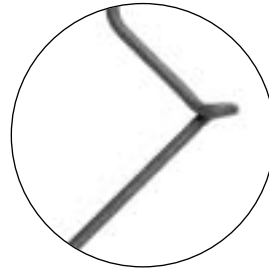
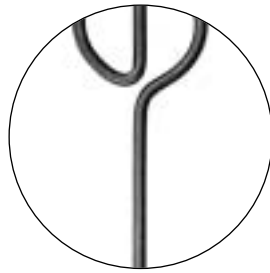
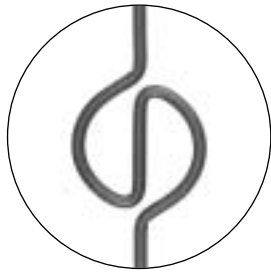

17 742

Anfangsverzierung

Endpost ornament

Ornement de départ

2,40 kg

Ø 75 mm

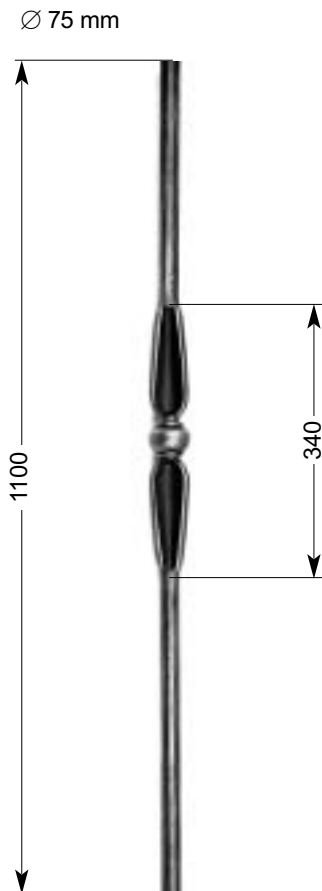

30 306

Anfangsstab

Endpost

Balustre de départ

4,72 kg

Ø 25 mm

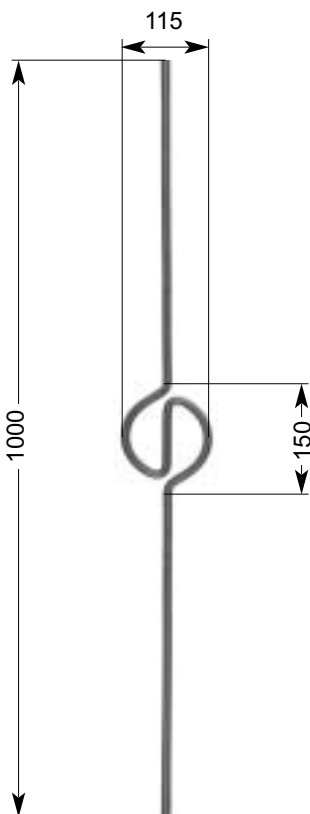

36 417

1,29 kg

Ø 12 mm

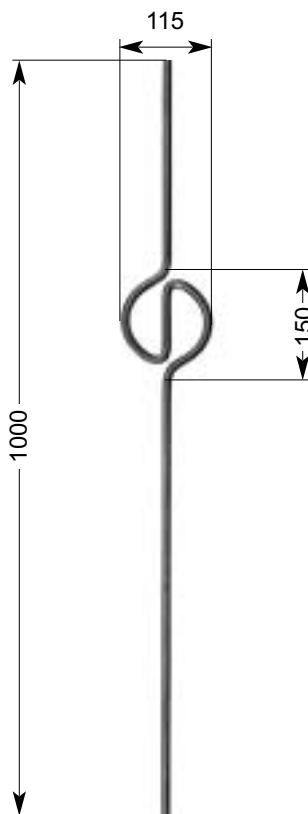

36 427

1,38 kg

Ø 12 mm

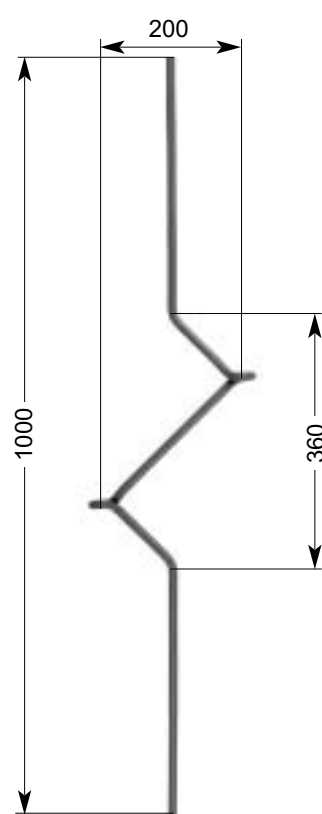

36 418

1,14 kg

Ø 12 mm

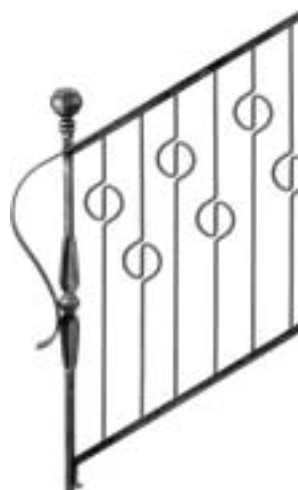

Triebbacher Schmiedeeisen

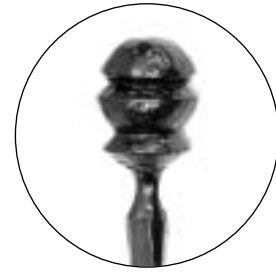
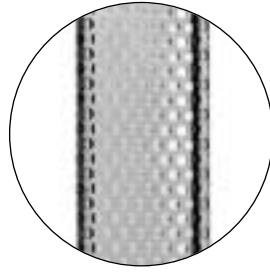
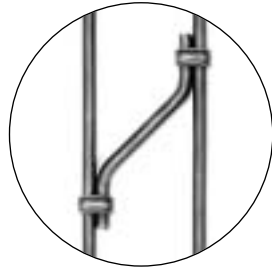
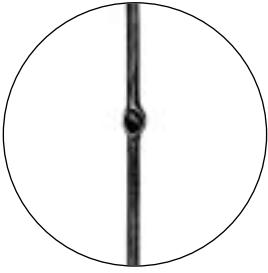

17 741

Anfangsverzierung

Endpost ornament

Ornement de départ

1,70 kg

Ø 65 mm

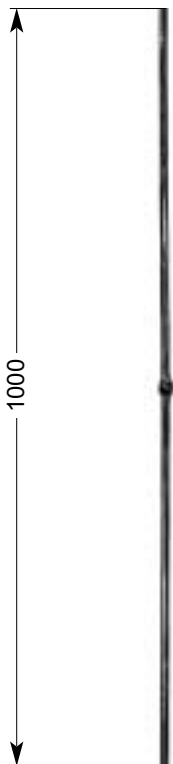

31 107
0,89 kg
Ø 12 mm

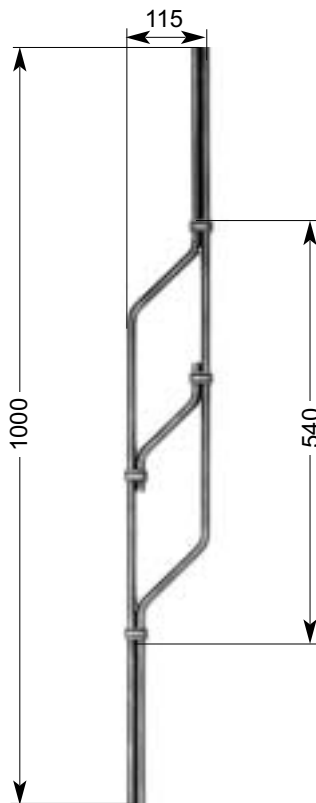

36 419
2,22 kg
Ø 12 mm

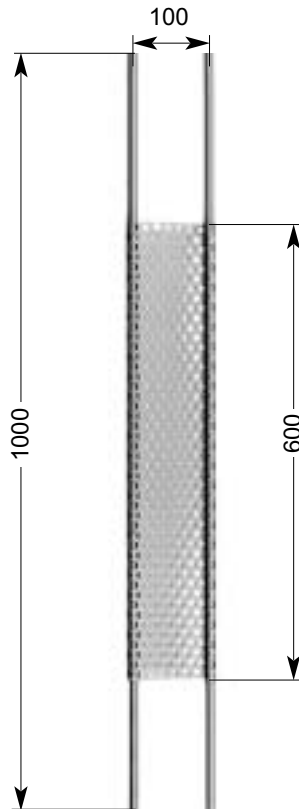

36 430
2,31 kg
Ø 12 mm

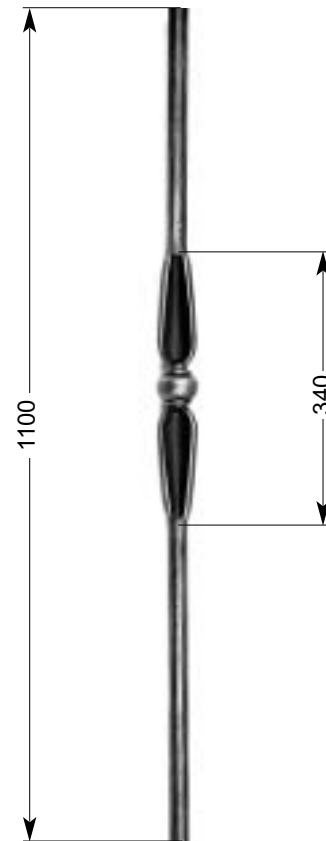

30 307

Anfangsstab mit Messingkugel

Endpost with brass ball

Balustre de départ

boule en laiton

4,72 kg

Ø 25 mm

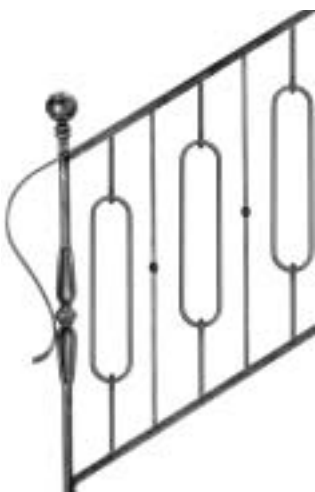



Zierstäbe

Maßstab 1:10

Ornamental balusters / Barreaux décoratifs

Scale / Echelle 1:10

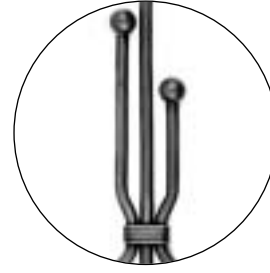
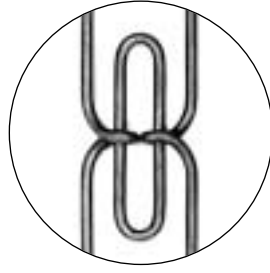

17 742

Anfangsverzierung

Endpost ornament

Ornement de départ

2,40 kg

Ø 75 mm

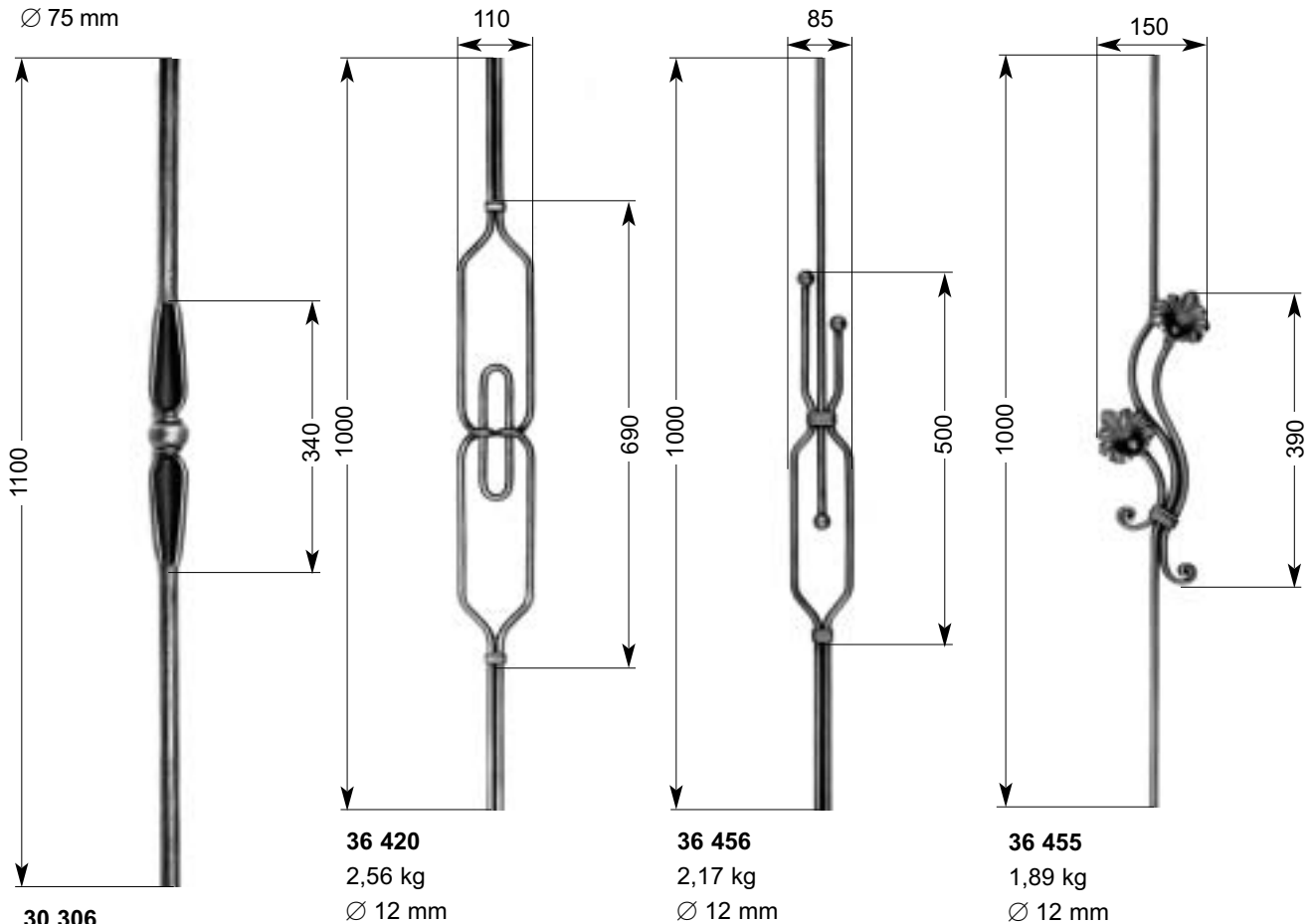

Triebenbacher Schmiedeeisen

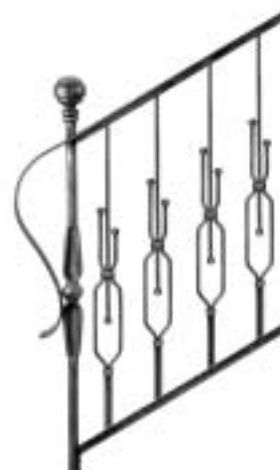
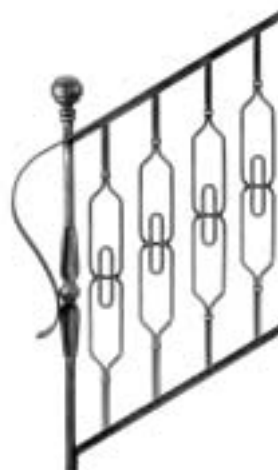

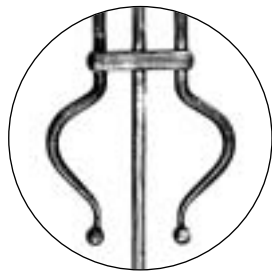
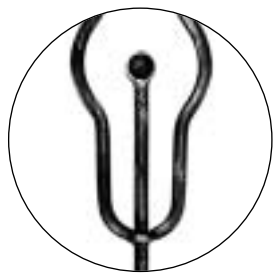
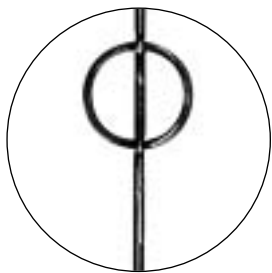

17 741

Anfangsverzierung

Endpost ornament

Ornement de départ

1,70 kg

Ø 65 mm

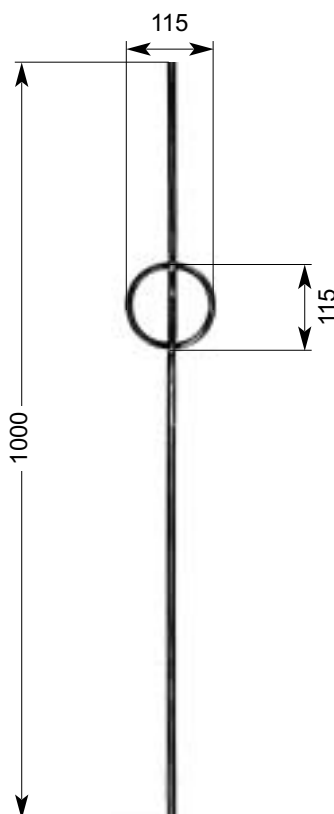

36 410
1,20 kg
Ø 12 mm

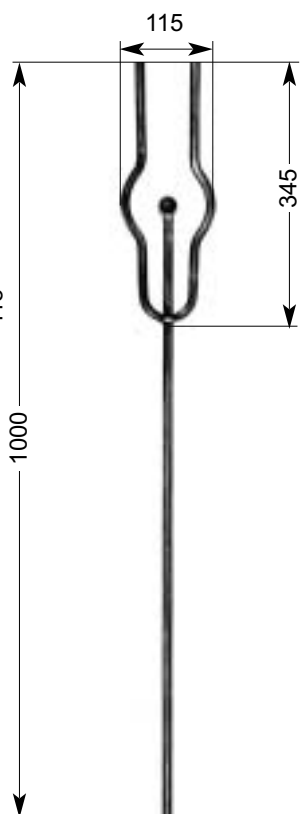

36 408
1,45 kg
Ø 12 mm

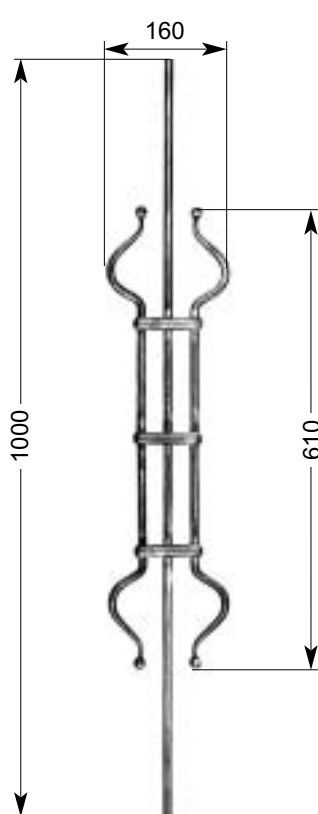

36 413
2,23 kg
Ø 12 mm

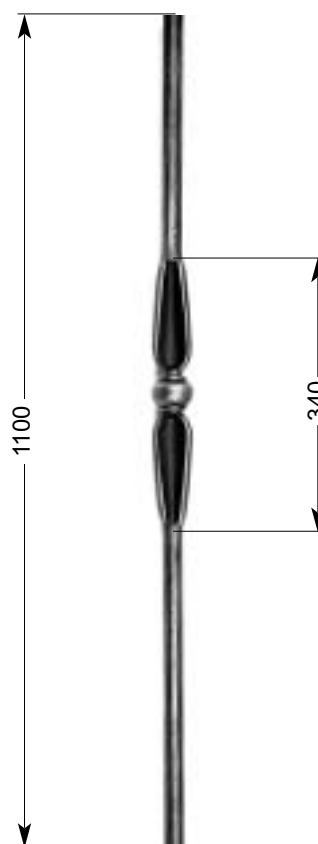

30 307

**Anfangsstab
mit Messingkugel**

Endpost with brass ball

Balustre de départ

boule en laiton

4,72 kg

Ø 25 mm

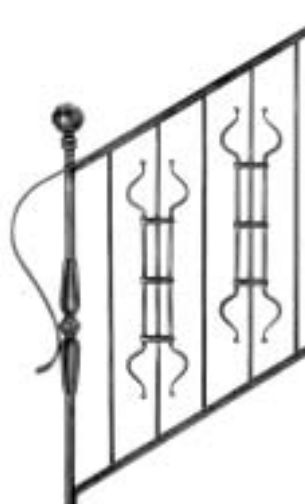
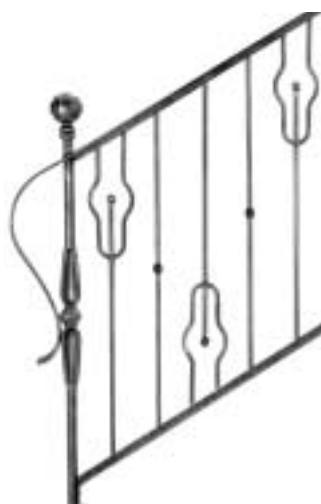



Zierstäbe

Maßstab 1:10

Ornamental balusters / Barreaux décoratifs

Scale / Echelle 1:10

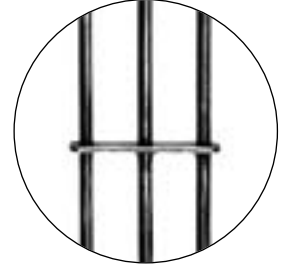
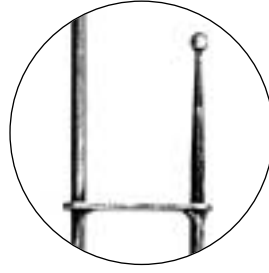
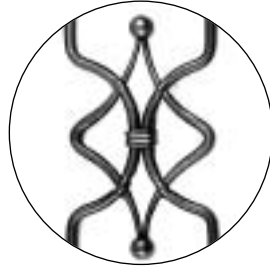

17 742

Anfangsverzierung

Endpost ornament

Ornement de départ

2,40 kg

Ø 75 mm

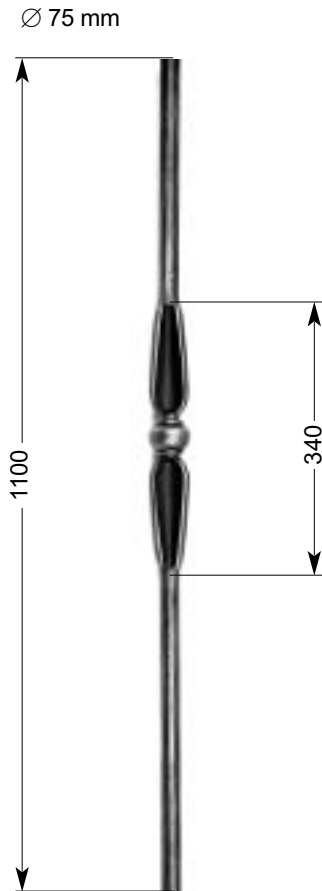

30 306

Anfangsstab

Endpost

Balustre de départ

4,72 kg

Ø 25 mm

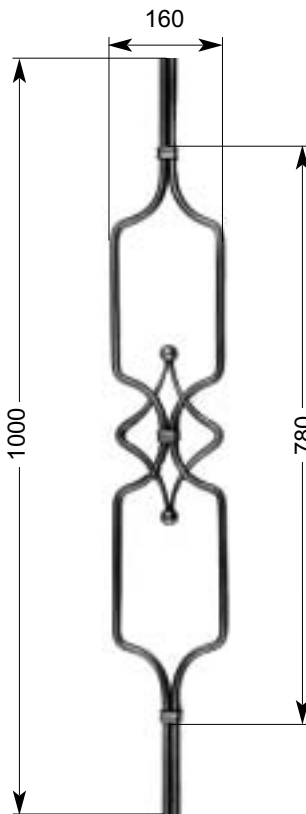

36 406

2,50 kg

Ø 12 mm

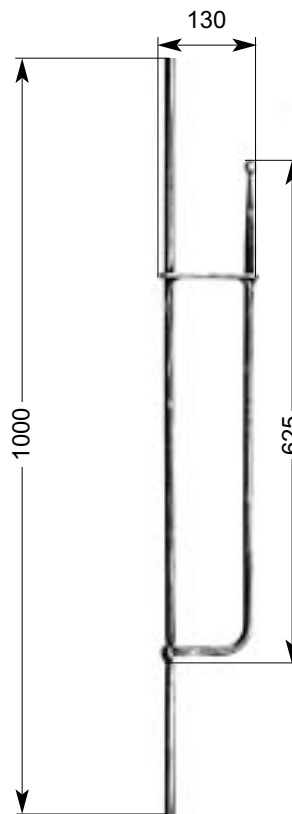

36 414

1,65 kg

Ø 12 mm

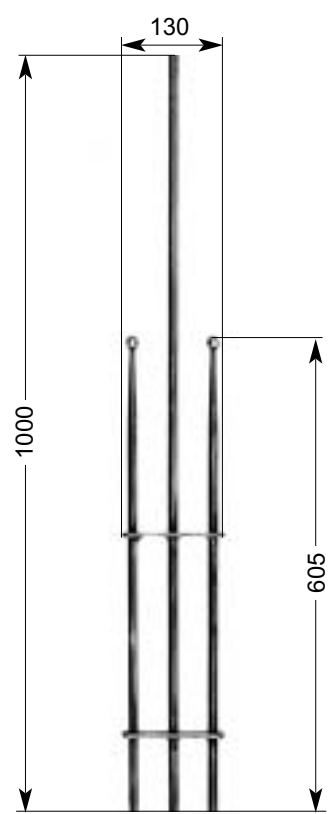

36 415

2,33 kg

Ø 12 mm

Triebbacher Schmiedeeisen

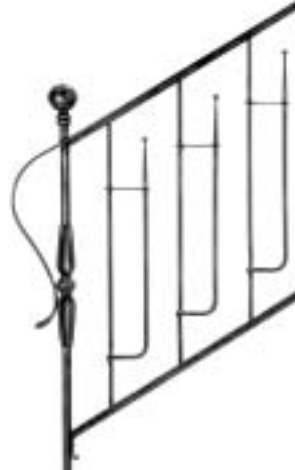
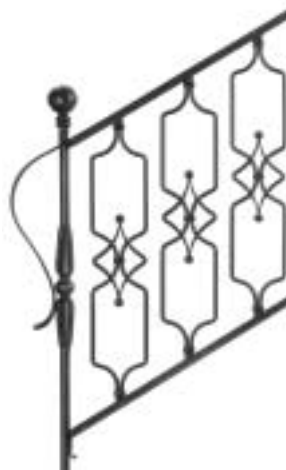

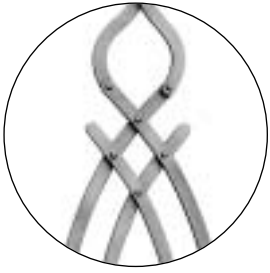

Verzierung
Ornament
Ornement
□ 12 x 5 mm

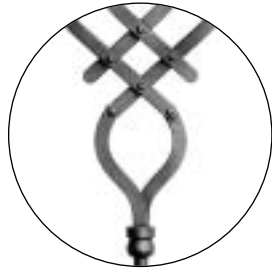

Verzierung
Ornament
Ornement
□ 12 x 5 mm

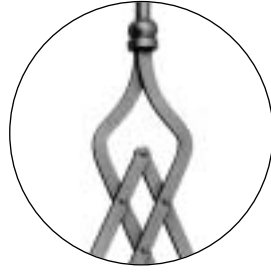

Verzierung
Ornament
Ornement
□ 12 x 5 mm

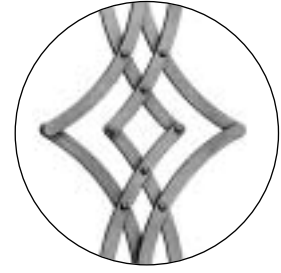

Verzierung
Ornament
Ornement
□ 12 x 5 mm

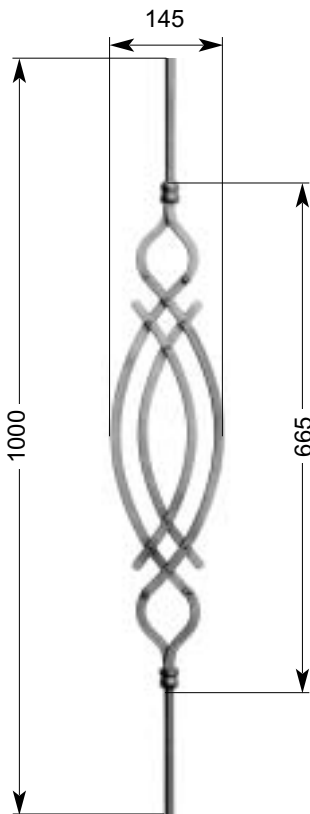

34 170
1,59 kg
Ø 12 mm

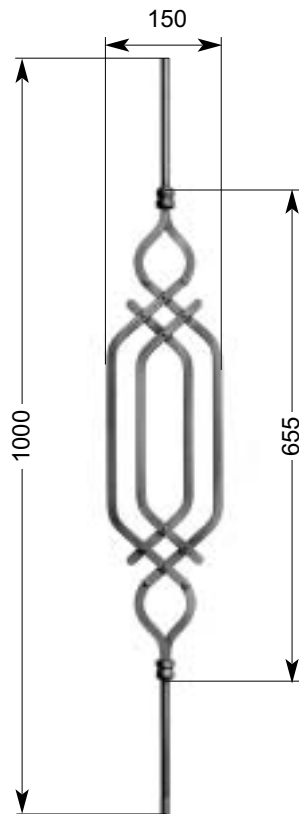

34 171
1,59 kg
Ø 12 mm

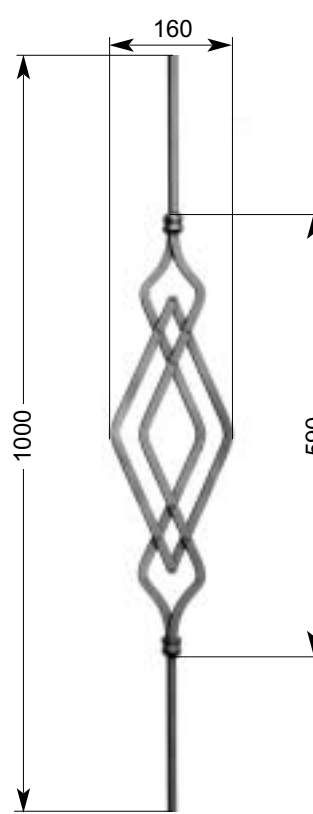

34 172
1,49 kg
Ø 12 mm

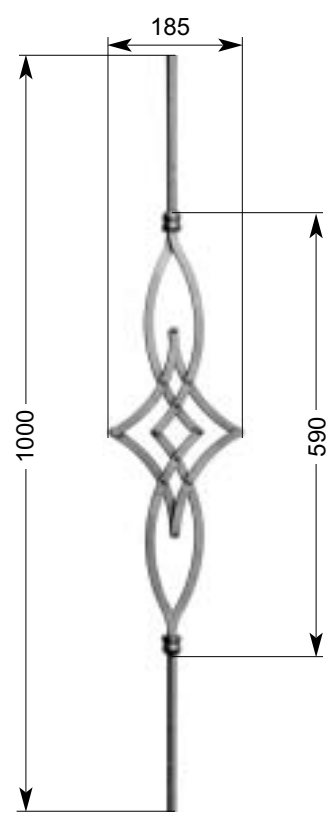

34 173
1,49 kg
Ø 12 mm



Triebener Eisen Schmiedeleisen