

# Residenz



Die elegante Linie  
aus 14 mm Rundmaterial



Triebener Eisen Schmiedeeisen



# Zierelemente

Maßstab 1:5

Ornamental elements / Eléments décoratifs

Scale / Echelle 1:5

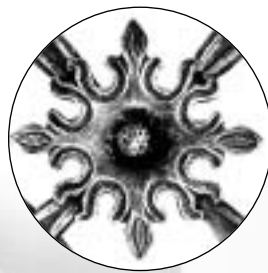

Triebenbacher Schmiedeeisen

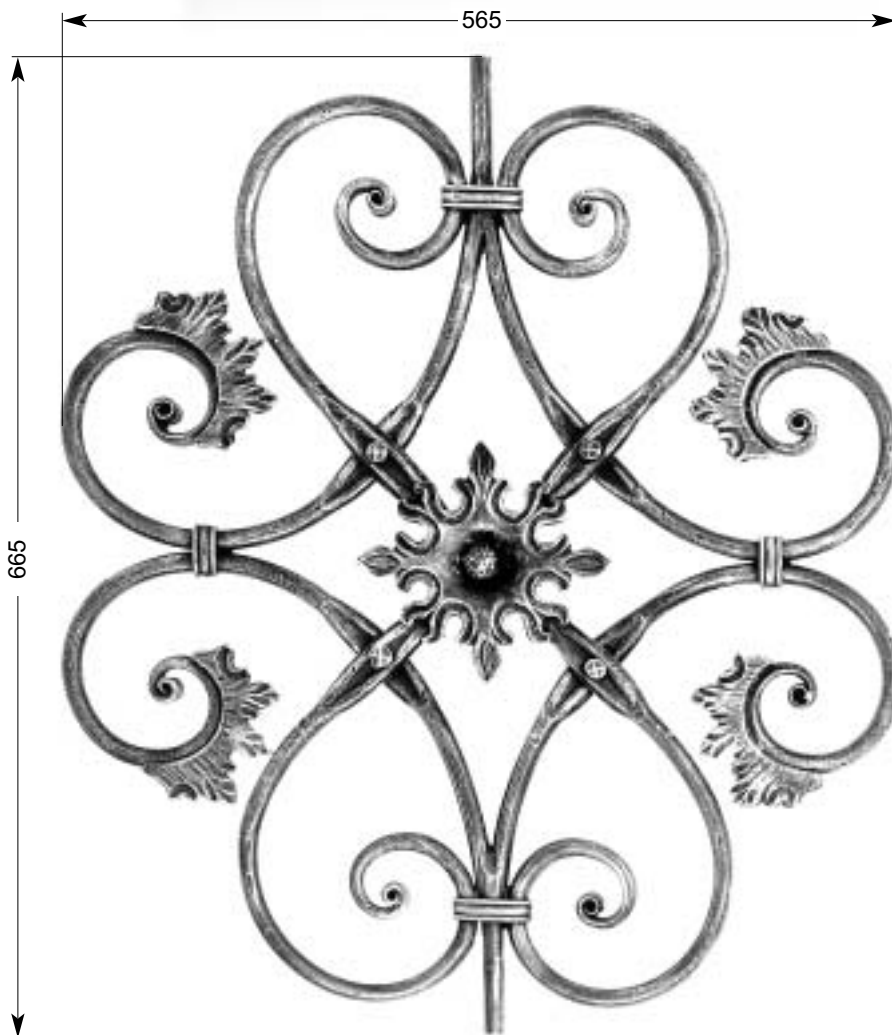

25 757  
7,87 kg  
Ø 14 mm

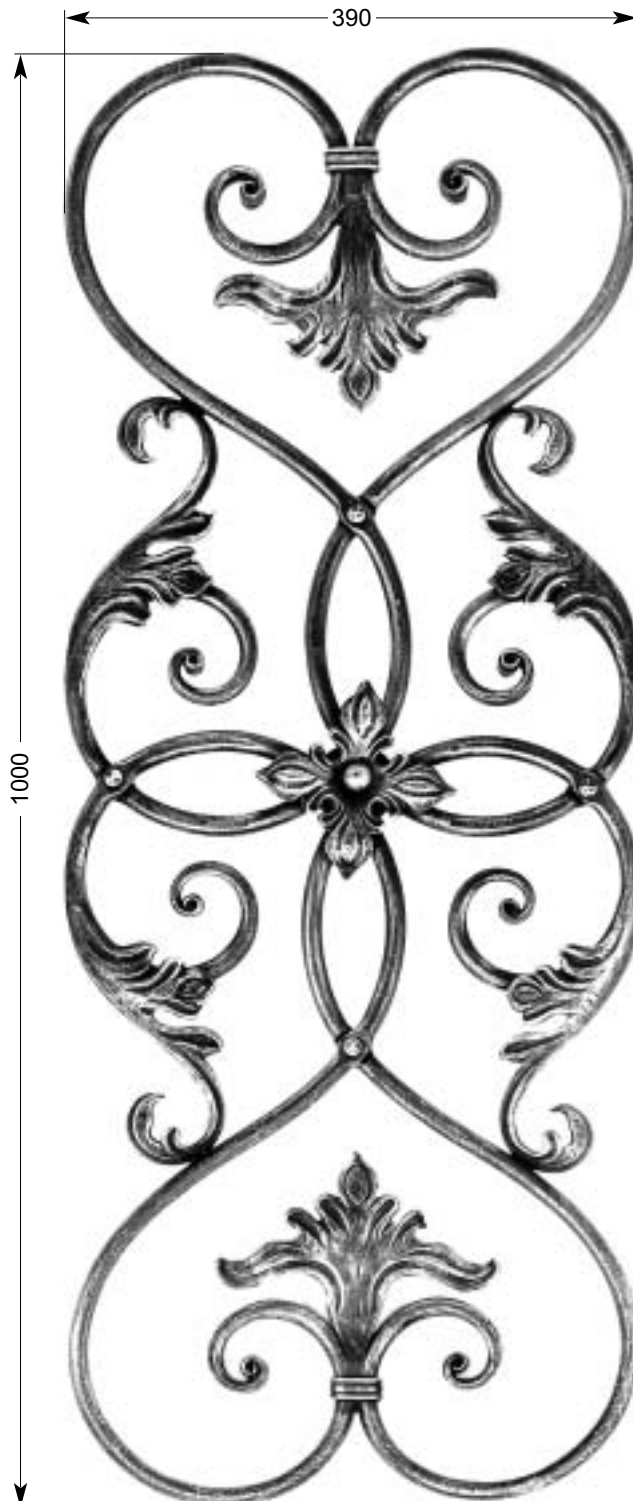

25 758  
8,80 kg  
Ø 14 mm

Triebbacher Schmiedeleisen



# Zierelemente

Maßstab 1:5

Ornamental elements / Éléments décoratifs

Scale / Echelle 1:5

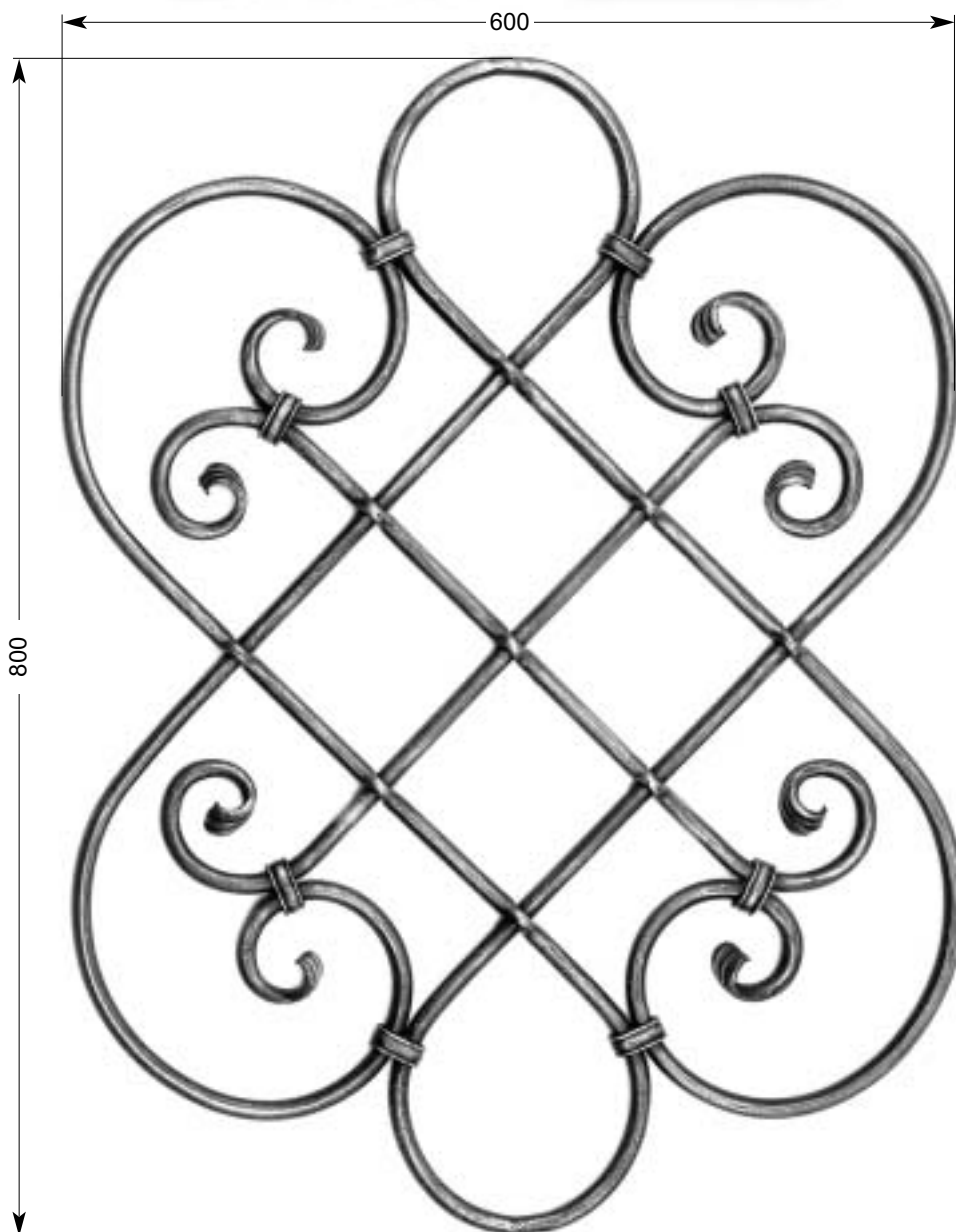
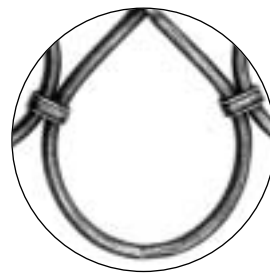

25 759  
8,80 kg  
Ø 14 mm

Triebener Schmiedeeisen





**25 760**  
7,69 kg  
Ø 14 mm

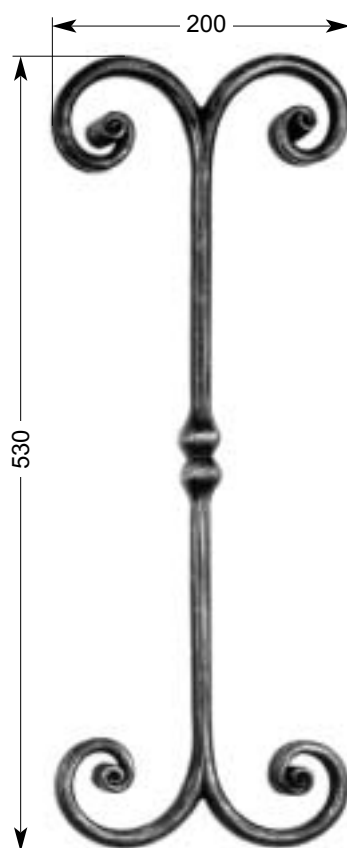

**25 737**  
1,80 kg  
Ø 14 mm

**Triebbacher Schmiedeeisen**



# Zierelemente

Maßstab 1:5

Ornamental elements / Éléments décoratifs

Scale / Echelle 1:5



25 755  
5,57 kg  
Ø 14 mm

Triebener Eisenwerke Schmiedeeisen



25 756  
5,57 kg  
Ø 14 mm

Triebener Schmiedeleisen



# Zierschnecken

Maßstab 1:5

Ornamental volutes / Volutes décoratifs

Scale / Echelle 1:5

Triebbacher Schmiedeleisen

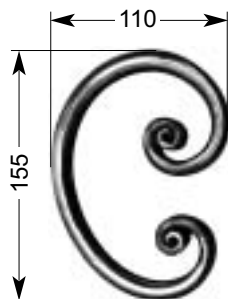

**25 606**  
0,62 kg  
Ø 14 mm

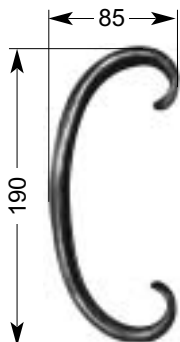

**25 601**  
0,39 kg  
Ø 14 mm

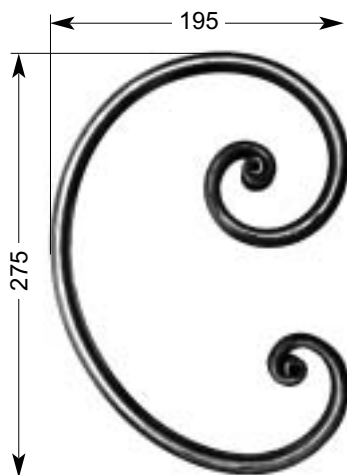

**25 607**  
1,18 kg  
Ø 14 mm

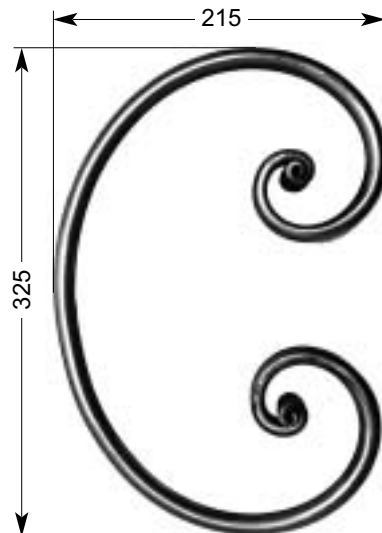

**25 604**  
1,31 kg  
Ø 14 mm



**25 642**  
1,00 kg  
Ø 14 mm

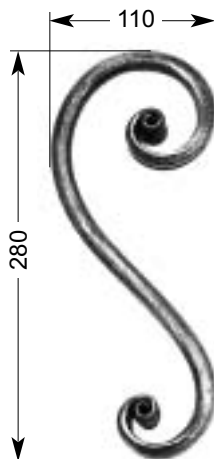

**25 641**  
0,74 kg  
Ø 14 mm



**25 640**  
0,59 kg  
Ø 14 mm

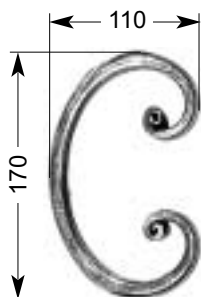

**25 603**  
0,60 kg  
Ø 14 mm

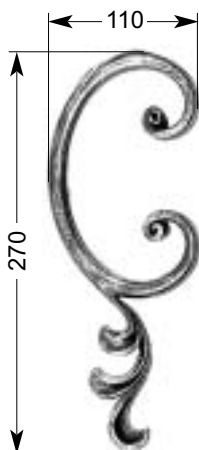

**25 631**  
0,68 kg  
Ø 14 mm



**25 632**  
0,68 kg  
Ø 14 mm



**25 609**  
0,74 kg  
Ø 14 mm



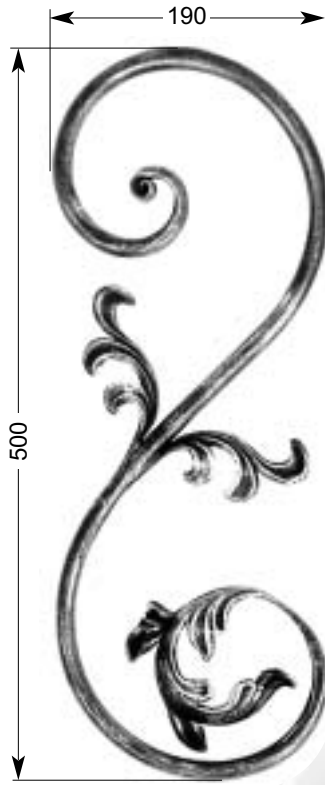

**25 651**  
1,68 kg  
Ø 14 mm

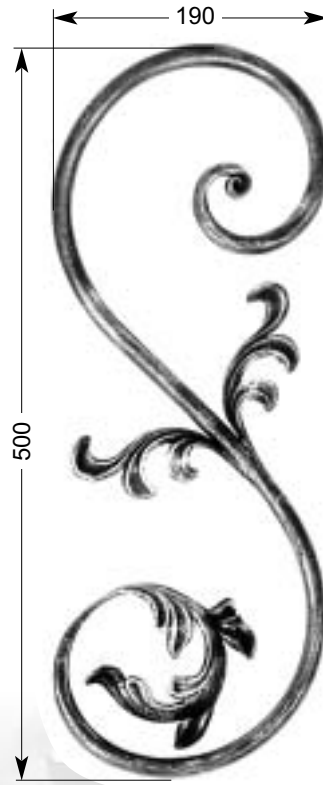

**25 652**  
1,68 kg  
Ø 14 mm



**25 629**  
1,92 kg  
Ø 14 mm

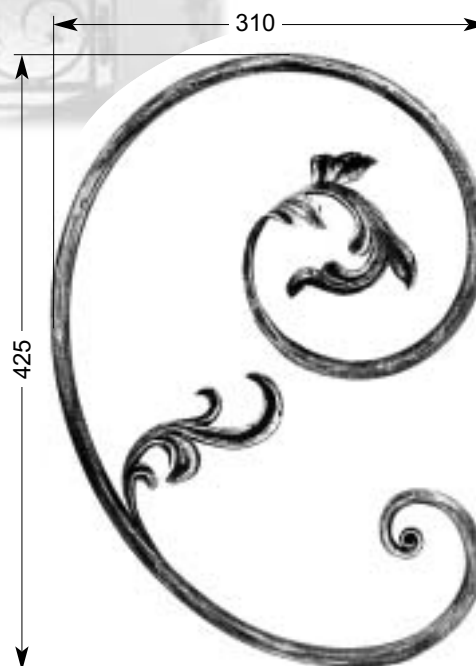

**25 630**  
1,92 kg  
Ø 14 mm



# Zierschnecken

Maßstab 1:5

Ornamental volutes / Volutes décoratifs

Scale / Echelle 1:5

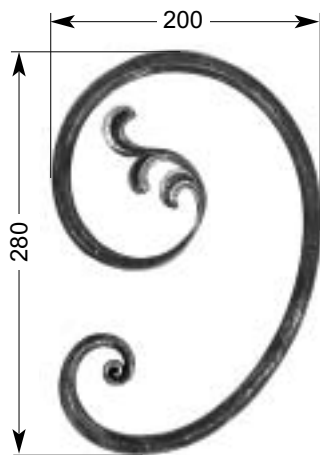

**25 623**  
1,04 kg  
Ø 14 mm

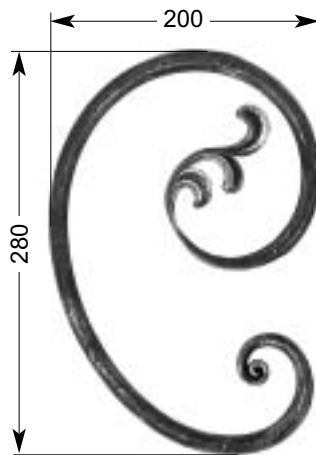

**25 624**  
1,04 kg  
Ø 14 mm

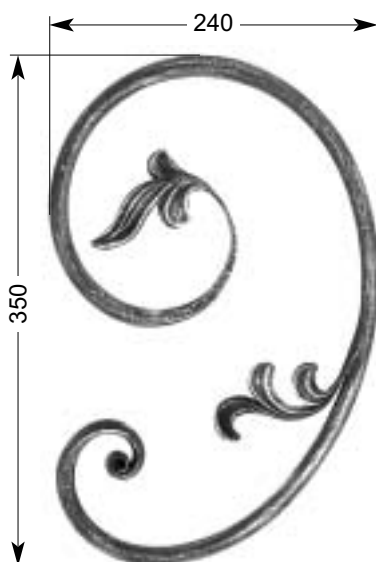

**25 625**  
1,45 kg  
Ø 14 mm



**25 626**  
1,45 kg  
Ø 14 mm

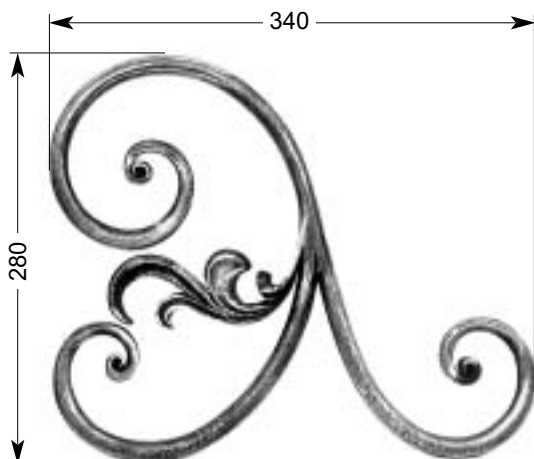

**25 751**  
1,77 kg  
Ø 14 mm

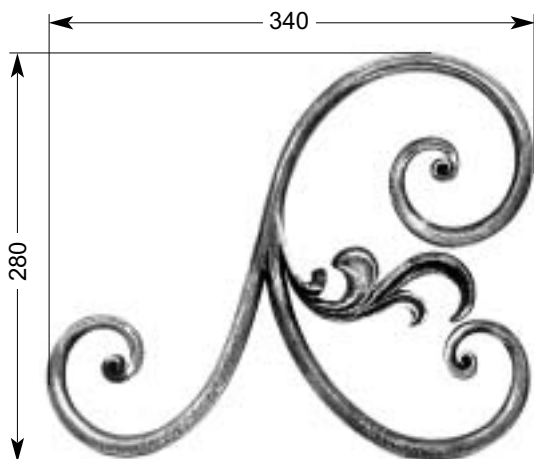

**25 752**  
1,77 kg  
Ø 14 mm

Triebacher Schmiedeeisen



**25 664**  
0,10 kg  
35 x 35 x 115 mm  
≡ 3,5 mm



**25 665**  
0,15 kg  
40 x 55 x 130 mm  
≡ 3,5 mm



**25 687**  
0,10 kg  
65 x 120 mm  
≡ 3,5 mm



**25 688**  
0,10 kg  
65 x 120 mm  
≡ 3,5 mm



**25 693**  
0,20 kg  
110 x 135 mm  
≡ 3,5 mm



**25 694**  
0,20 kg  
110 x 135 mm  
≡ 3,5 mm



**25 661**  
0,11 kg  
80 x 110 mm  
≡ 3,5 mm



**25 713**  
0,37 kg  
195 x 195 mm  
≡ 3,5 mm



**25 717**  
0,50 kg  
130 x 240 mm  
≡ 3,5 mm



**25 718**  
0,33 kg  
105 x 265 mm  
≡ 3,5 mm



# Zierelemente

Maßstab 1:5

Ornamental elements / Eléments décoratifs

Scale / Echelle 1:5

Triebenbacher Schmiedeeisen



**25 730**  
0,36 kg  
Ø 110 mm  
Ø 14 mm



**25 731**  
0,46 kg  
110 x 150 mm  
Ø 14 mm



**25 732**  
0,54 kg  
110 x 180 mm  
Ø 14 mm



**25 710**  
0,17 kg  
Ø 70 mm  
H. 55 mm  
≡ 3,5 mm



**25 711**  
0,48 kg  
Ø 100 mm  
H. 100 mm  
≡ 3,5 mm



**25 714**  
0,23 kg  
130 x 195 mm  
≡ 3,5 mm



**24 514**  
0,17 kg  
Ø 95 mm  
≡ 3,5 mm



**24 515**  
0,17 kg  
Ø 135 mm  
≡ 3,5 mm



**24 708**  
0,30 kg  
Ø 170 mm  
≡ 3,5 mm



**24 516**  
0,36 kg  
Ø 195 mm  
≡ 3,5 mm





**Rahmenträger**  
in der Broschüre Langmaterial  
Frame brackets  
in the brochure long material  
Supports de cadre  
dans le catalogue produit long



**Türdrücker**  
in der Broschüre Beschläge  
Door handle  
in the brochure door mountings  
Bouton de porte  
dans le catalogue ferrues de port



**Handlaufträger**  
in der Broschüre Langmaterial  
Handrail brackets  
in the brochure long material  
Supports de main courante  
dans le catalogue produit long



**Torbänder**  
in der Broschüre Beschläge  
Door hinges  
in the brochure door mountings  
Paumelles de porte  
dans le catalogue ferrues de port



**Vierkantrohre**  
in der Broschüre Langmaterial  
Square tubes  
in the brochure long material  
Tubes carrés  
dans le catalogue produit long

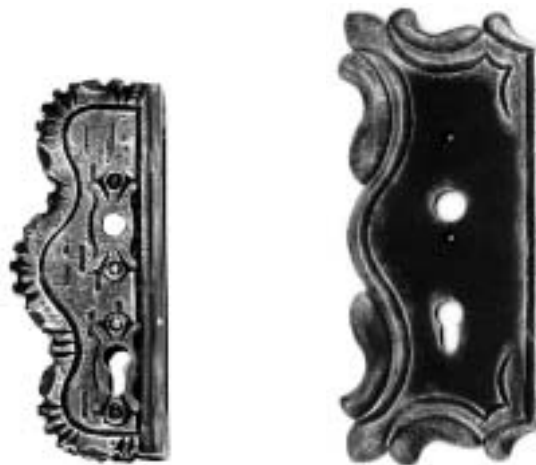

**Schlösser und Schloßkästen**  
in der Broschüre Beschläge  
Locks and lock cases  
in the brochure door mountings  
Serrures et boîtes de serrure  
dans le catalogue ferrues de port



# Bundmaterial

Maßstab 1:2

Flange material / Fers à grilles

Scale / Echelle 1:2

Bunde / Flanges / Fers

100 St. / pcs. / pcs.

11704 Material / Material / Fers

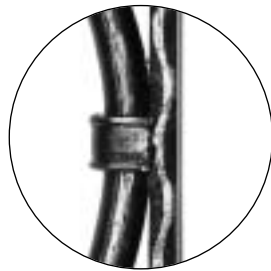

**21 365**  
1,79 kg  
) | 14 mm

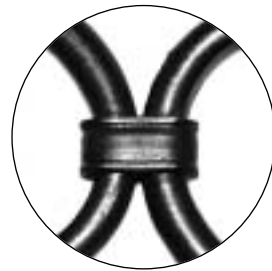

**21 366**  
3,58 kg  
) ( 14 - 14 mm

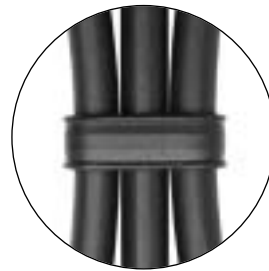

**21 367**  
4,76 kg  
) ( 14 - 14 - 14 mm



**21 376**  
3,90 kg  
|| 14 - 14 - 14 mm

| = gerade Verbindung / for parallel connection / pour produit droit  
) = leicht gebogene Verbindung / for volutes elements / pour assemblage volutes  
> = stark gebogene Verbindung / for circles / pour assemblage cercle

Maßstab 1:1 / Scale / Echelle

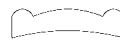

**11 704**  
Bundmaterial 0,34 kg / m  
Flange material L. 3 m  
Fers à grilles 16 x 4 mm

Handrail material / Matériel de main-courante  
Scale / Echelle 1:2

## Handläufe

Maßstab 1:2

Die komplette Auswahl an Handläufen ist in unserer Broschüre Langmaterial  
The complete collection of handrails you will find in our brochure long material  
Toute les main courante dans le catalogue produit long

Maßstab 1:1 / Scale / Echelle

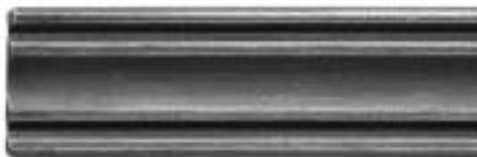

**11 930**  
2,26 kg / m  
L. 3 m  
41 x 8 mm

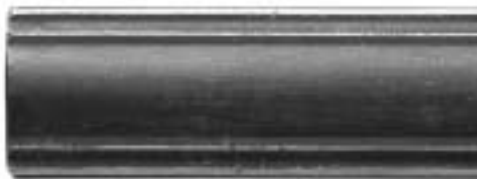

**11 950**  
3,40 kg / m  
L. 3 m  
45 x 13 mm



**11 960**  
2,50 kg / m  
L. 3 m  
40 x 10 mm

Triebwägenbau  
Schmiedeteile

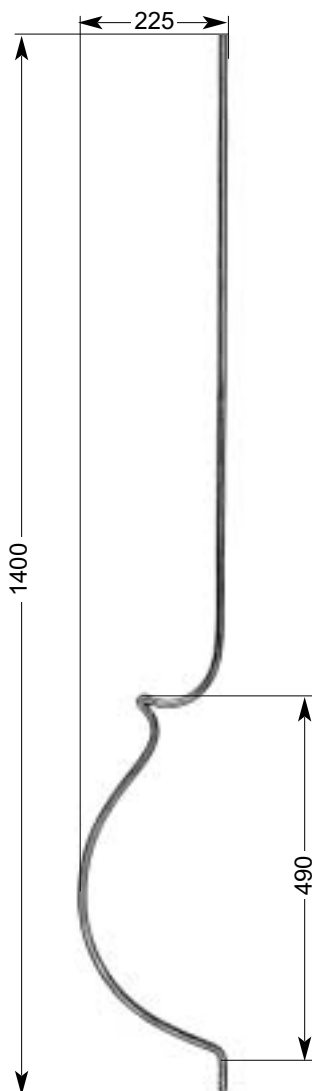

**32 121**  
**Korbstab**  
Convex grille bar  
Barreaux de grille  
en anse-de-panier  
1,95 kg  
Ø 14 mm

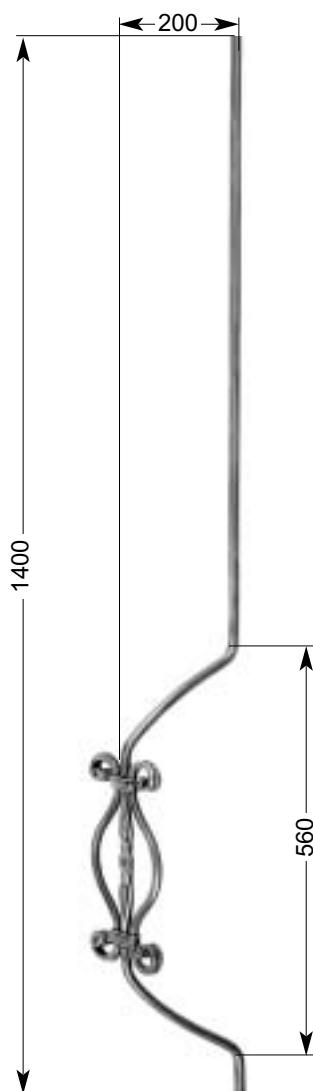

**32 144**  
**Korbstab**  
Convex grille bar  
Barreaux de grille  
en anse-de-panier  
2,87 kg  
Ø 14 mm

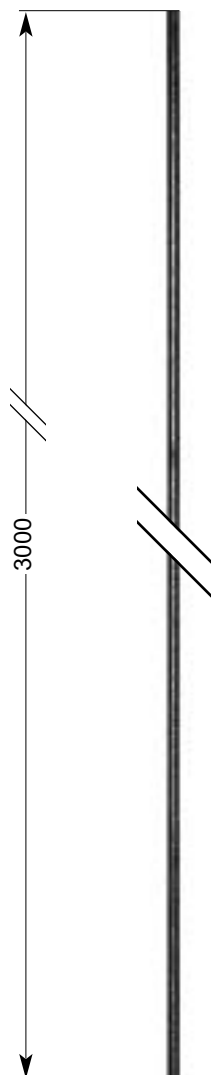

**12 114**  
**Rundmaterial**  
Roundmaterial  
Matériel ronde  
1,21 kg / m  
L. 3 m  
Ø 14 mm

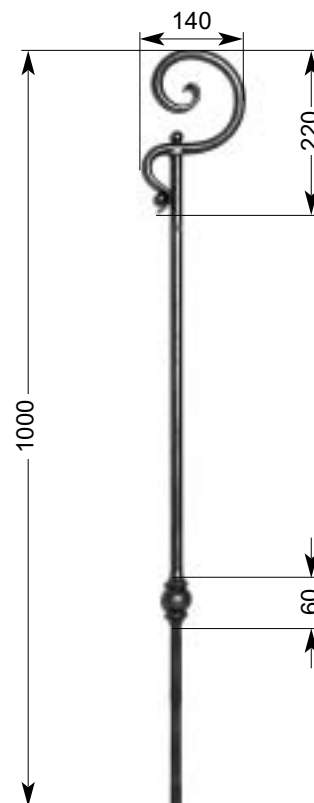

**35 630**  
1,91 kg  
Ø 14 mm

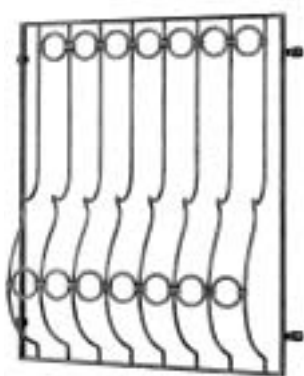



# Zierstäbe

Maßstab 1:10

Ornamental balusters / Barreaux décoratifs

Scale / Echelle 1:10

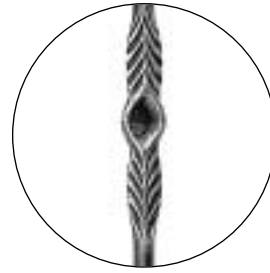
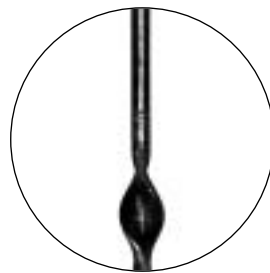
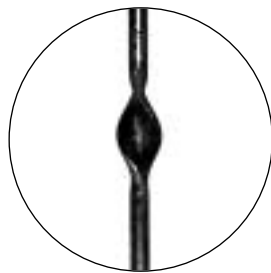

**17 744**

## Handlaufverzierung

Handrail ornament

Ornement de main-courante

4,30 kg

Ø 90 mm

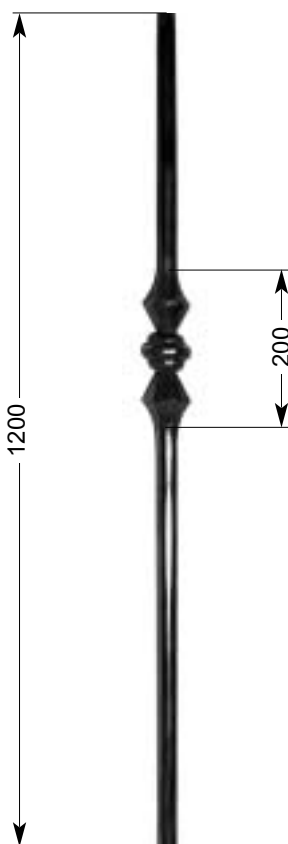

**30 516\***

## Anfangsstab

Endpost

Balustre de départ

7,20 kg

Ø 25 mm

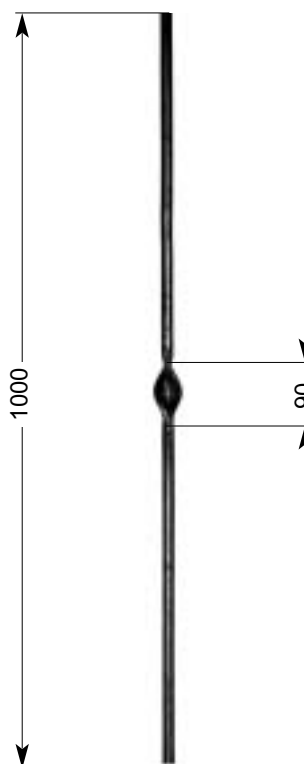

**35 621**

1,18 kg

Ø 14 mm

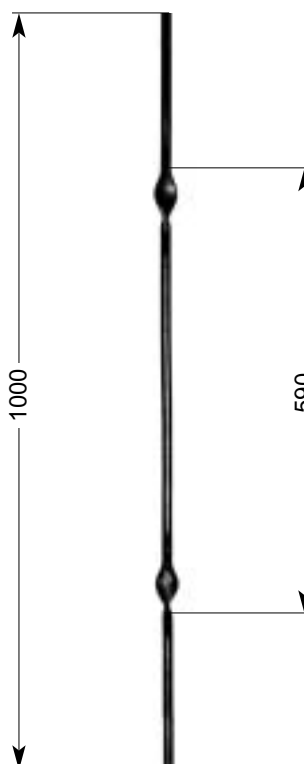

**35 622**

1,18 kg

Ø 14 mm

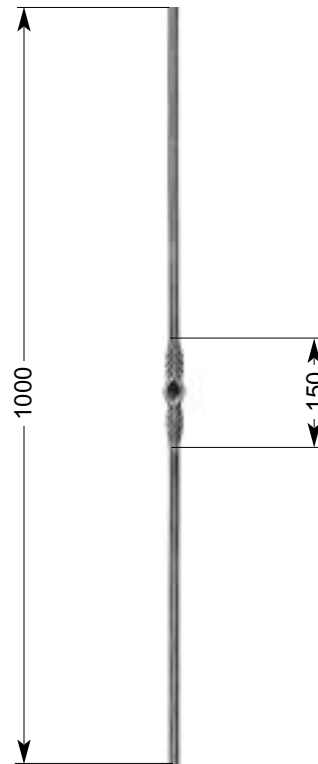

**35 601**

1,18 kg

Ø 14 mm



Triebbacher Schmiedeeisen



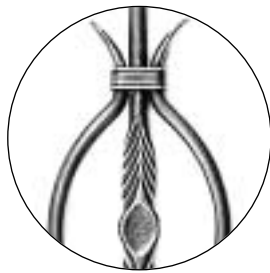
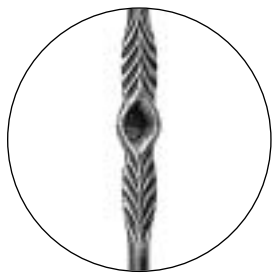
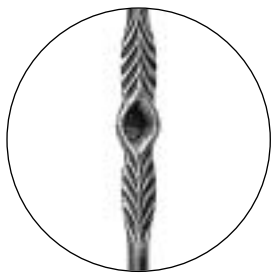

17 742

**Handlaufverzierung**

Handrail ornament

Ornement de main-courante

2,40 kg

Ø 75 mm

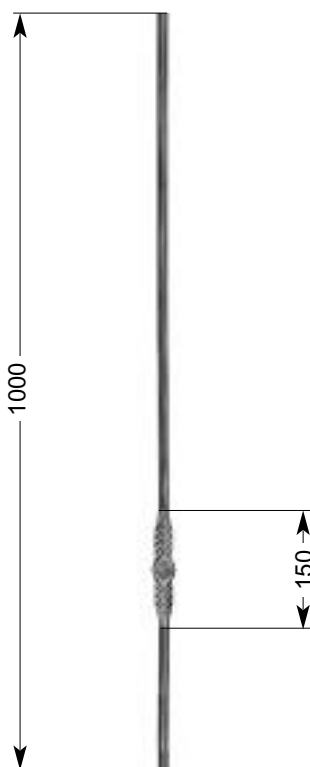

**35 602**  
1,18 kg  
Ø 14 mm

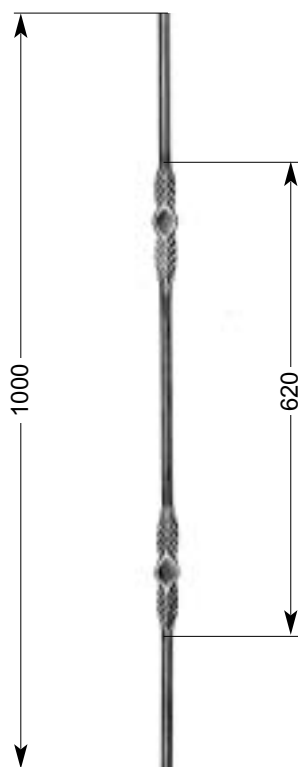

**35 603**  
1,18 kg  
Ø 14 mm

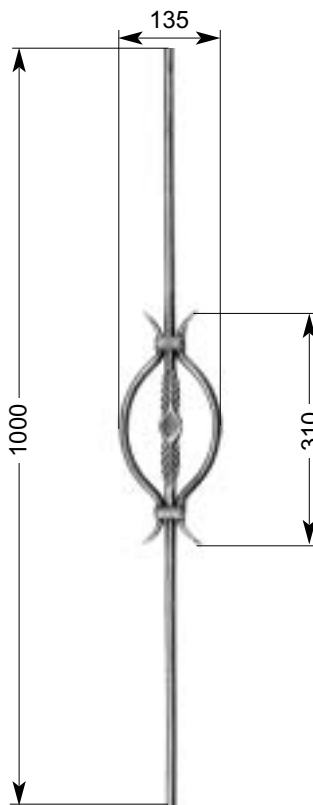

**35 604**  
1,85 kg  
Ø 14 mm

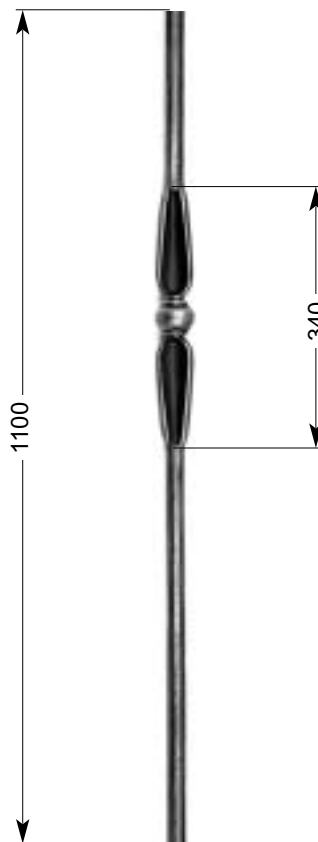

30 306

**Anfangsstab**

Endpost

Balustre de départ

4,72 kg

Ø 25 mm





# Zierstäbe

Maßstab 1:10

Ornamental balusters / Barreaux décoratifs

Scale / Echelle 1:10

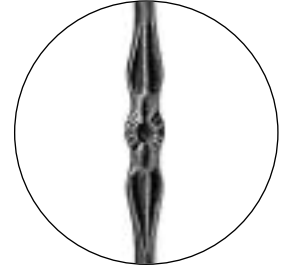
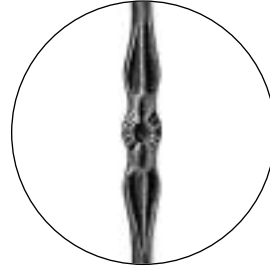
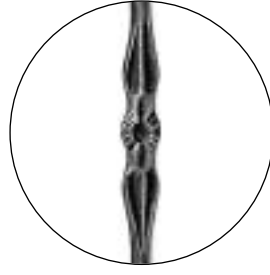

**17 744**

**Handlaufverzierung**

Handrail ornament

Ornement de main-courante

4,30 kg

Ø 90 mm

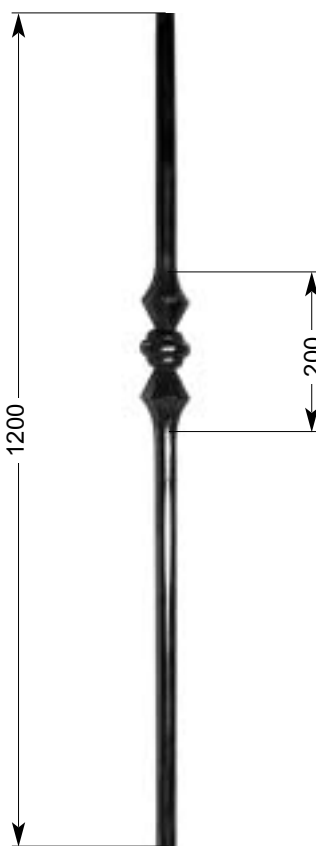

**30 516\***

**Anfangsstab**

Endpost

Balustre de départ

7,20 kg

Ø 25 mm

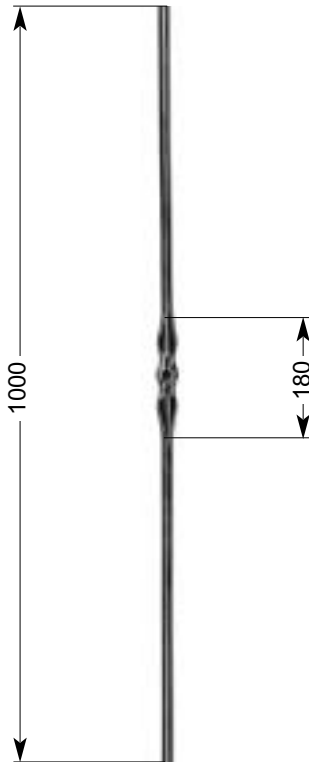

**35 611**

1,18 kg

Ø 14 mm

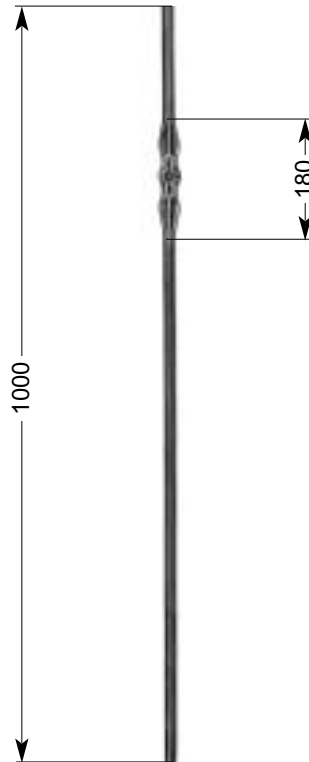

**35 612**

1,18 kg

Ø 14 mm

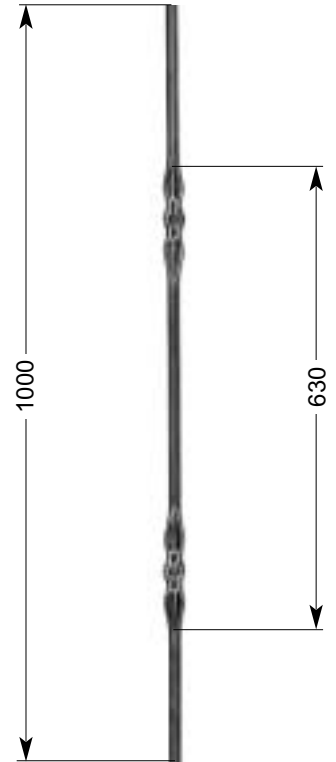

**35 613**

1,18 kg

Ø 14 mm



Triebbacher Schmiedeeisen

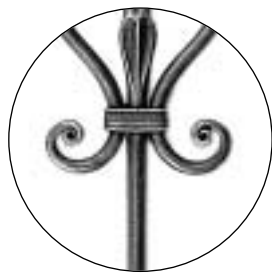
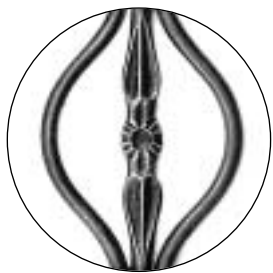

17 742

**Handlaufverzierung**

Handrail ornament

Ornement de main-courante

2,40 kg

Ø 75 mm

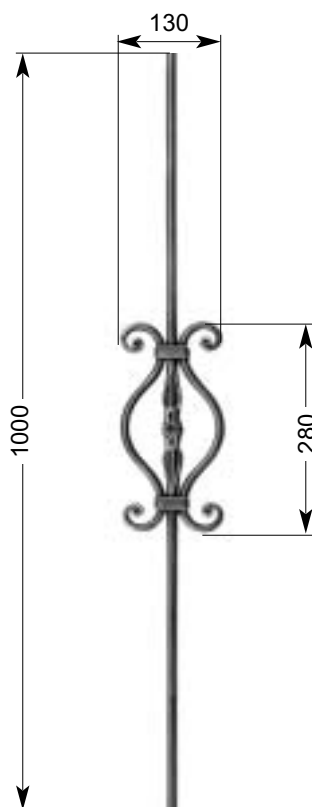

**35 614**  
2,14 kg  
Ø 14 mm

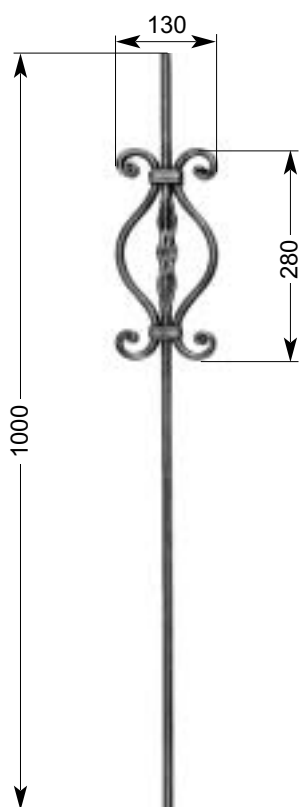

**35 615**  
2,14 kg  
Ø 14 mm

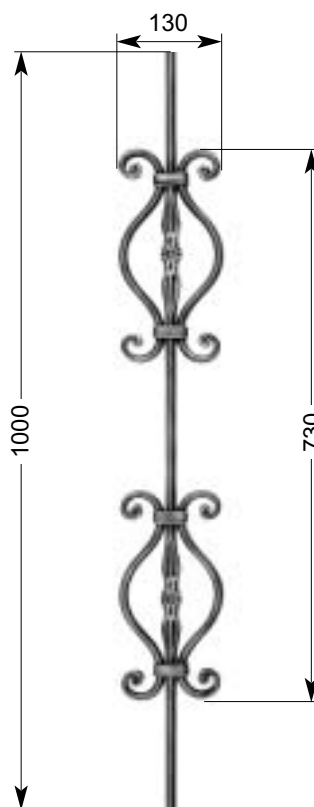

**35 616**  
3,10 kg  
Ø 14 mm

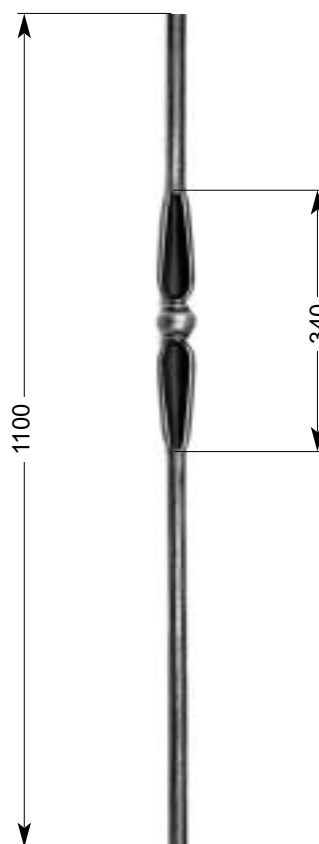

30 306

**Anfangsstab**

Endpost

Balustre de départ

4,72 kg

Ø 25 mm

